

LV

8500 Series

LV8500R/L | LV8500RM/LM

HYUNDAI WIA Vertical Turning Center

Technical Leader

Flexible, Productive Automation System Vertical Turning Center

The CNC Turning Center LV8500 Series, designed by Hyundai WIA with years of expertise and the latest technology, is designed to maximize productivity by high speed and accurate performance.

LV8500 Series

Max. Turning Dia.	mm(in)	Ø850 (Ø33.5")		
Max. Turning Length	mm(in)	800 (31.5")		
Chuck Size	inch	18"	[21"]	[24"]
Spindle Speed	r/min	2,000	[1,940]	[1,760]
Spindle Power (10min./30min./Cont.)	kW(HP)	Belt : 37/30/22 (50/40/29.5) [Gear Box : 45/37/30 (60/50/40)]		
Travel (X/Z)	mm(in)	465/800 (18.3"/31.5")		
No. of Tools	EA	12		

[] : Option

LV

8500 Series

High Productivity, Heavy Duty Vertical Turning Center

- “Right” and “Left” structure for practical automation construction
- Stable spindle structure with excellent heavy duty cutting ability
- 2 step pressure chucking system (Opt.)
- BMT turret applied for heavy duty cutting (Mill turret models)
- Designed for optimal chip disposal



01 BASIC STRUCTURE

High Speed & Heavy Duty Cutting Vertical CNC Turning Center

Turret

- Highly Reliable Servo Turret
- No. of Tools : 12EA
- indexing Time : 0.2 sec
- BMT75 ('M' Type)

High Precision Spindle

- 18" [21"/24"]
- 2,000 r/min
- Spindle Nose : A2-11 [24" : A2-15]
- C-Axis Control : 0.001° ('M' Type)

Max. Turning Dia. Increase

Previous model

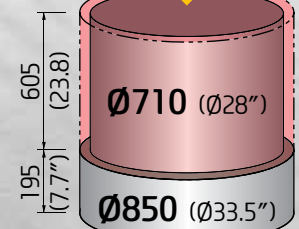
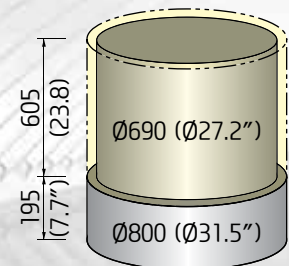

LV8500 Series

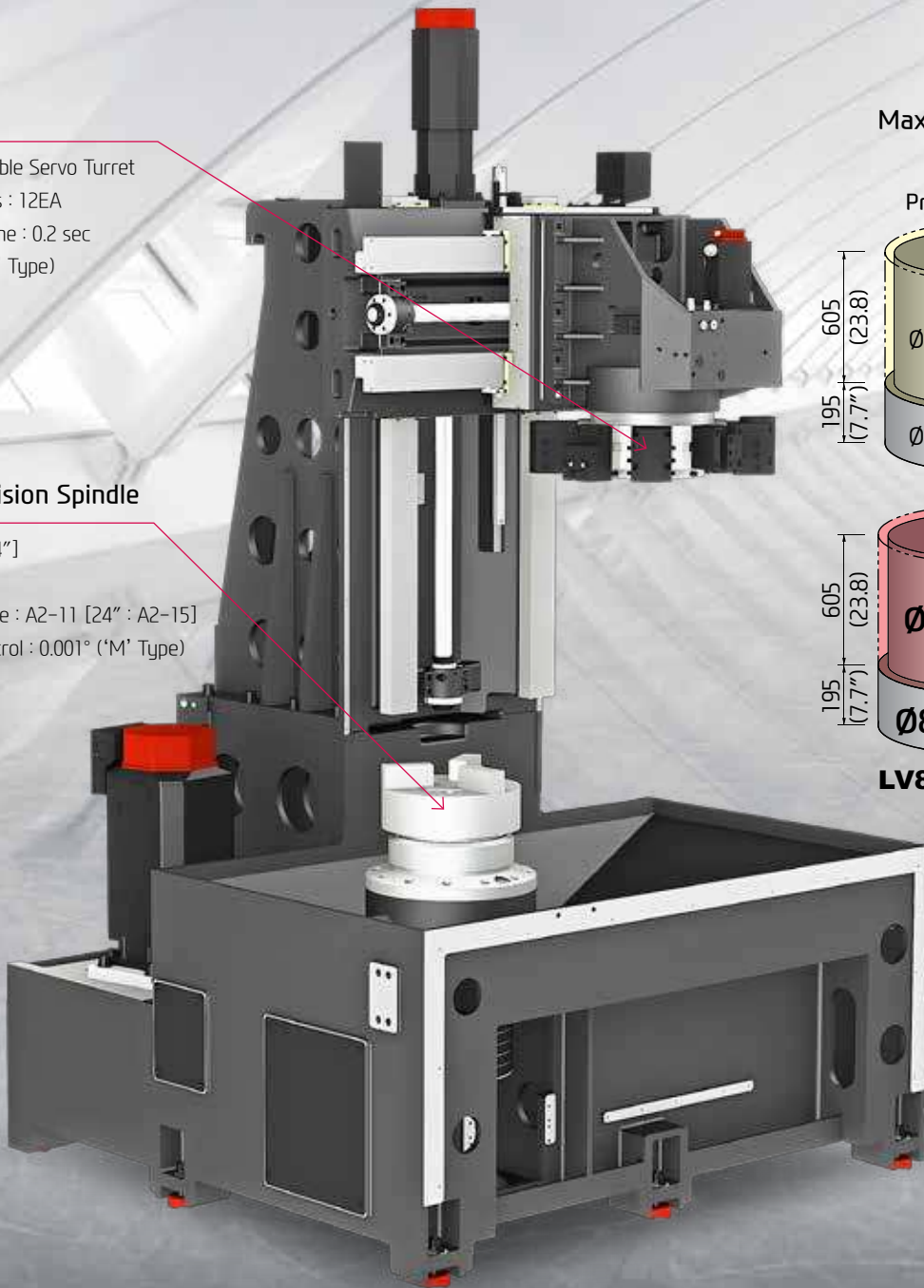

STRUCTURE FOR HEAVY CUTTING & HIGH PRECISION

HIGH-PRECISION STRUCTURE

Automation Configuration Structure

The LV8500 Series consists of Left and Right machine configuration, allowing for more efficient automation options.

Oil and Air devices are located in front of the machine for easy repair and maintenance.

Front Operation Structure

The power supply, hydraulic device and lubrication device are all designed to be controlled on the front side of the machine , leading to enhanced user convenience.



GUIDEWAY

Box Guideway

All axes of the LV8500 Series feature box guideways. Box guideways provide long term rigidity and accuracy even during heavy duty operations.

Ball Screw

Large diameter ball screws with preloading prevent deformation due to heat. Also double-anchor support method improves rigidity.



⦿ Z-axis Ball Screw : Increased dynamic rigidity

Previous model 6,356 kg (14,013 lb)

LV8500 Series 12,323 kg (27,168 lb) UP by 90%

Travel (X/Z)

465/800 mm (18.3"/31.5")

Rapid Traverse Rate (X/Z)

20/20 m/min (787/787 ipm)

02 HIGH PRECISION SPINDLE

Long Lasting, High Accuracy & Excellent Performance CNC Turning Center

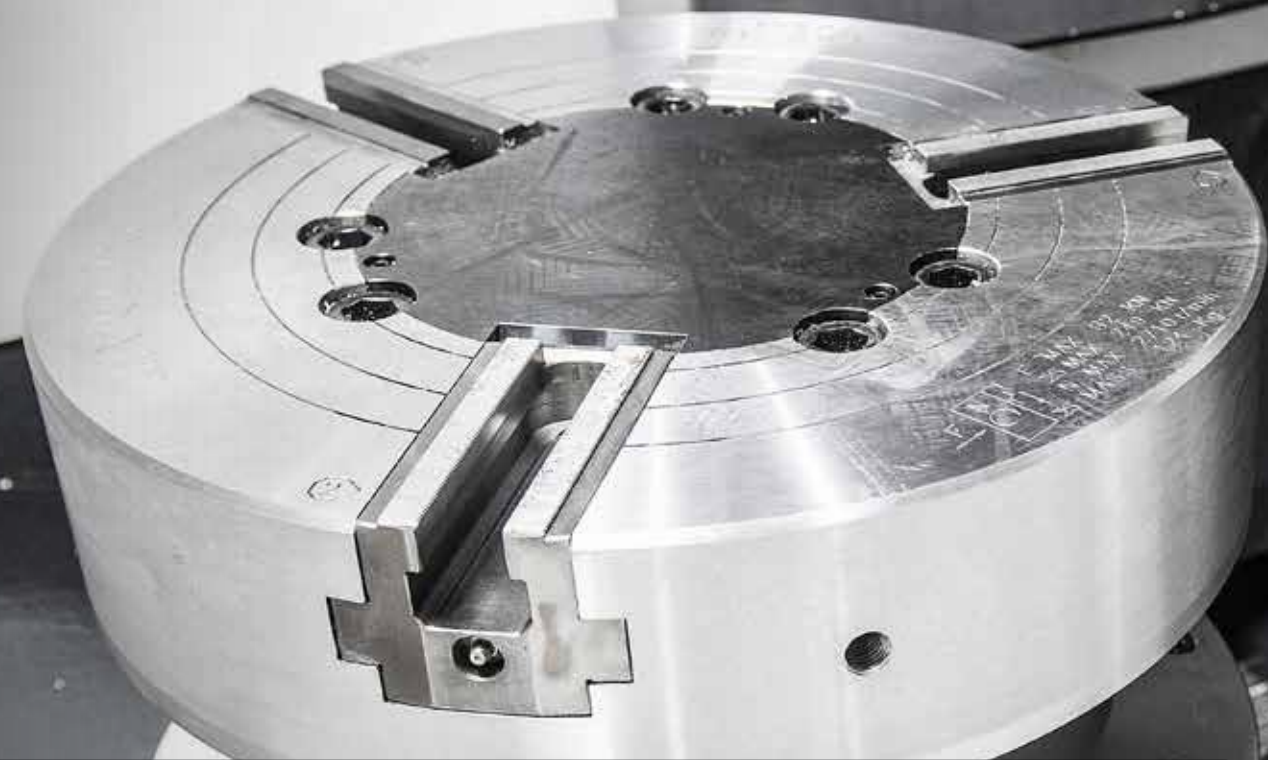

Spindle Specifications

[] : Option

Chuck Size	Spindle Speed	Power (Max./30min/Cont.)	Torque (Max./30min/Cont.)	Driving Method
18"	2,000 r/min	37/30/22 kW (50/40/29.5 HP)	1,660/1,346/986 N·m (1,224.4/992.8/727.2 lbf·ft)	Belt
		[45/37/30 kW] [(60/40/30 HP)]	[3,185/2,619/2,124 N·m] [(2,349.1/1,931.7/1,566.6 lbf·ft)]	Gear Box
[21"]	[1,940 r/min]	[37/30/22 kW] [(50/40/29.5 HP)]	[1,660/1,346/986 N·m] [(1,224.4/992.8/727.2 lbf·ft)]	Belt
		[45/37/30 kW] [(60/40/30 HP)]	[3,494/2,873/2,329 N·m] [(2,577/2,119/1,717.8 lbf·ft)]	Gear Box
[24"]	[1,760 r/min]	[37/30/22 kW] [(50/40/29.5 HP)]	[1,660/1,346/986 N·m] [(1,224.4/992.8/727.2 lbf·ft)]	Belt
		[45/37/30 kW] [(60/40/30 HP)]	[3,494/2,873/2,329 N·m] [(2,577/2,119/1,717.8 lbf·ft)]	Gear Box

HEAVY DUTY CUTTING & HIGH ACCURACY

SPINDLE

Spindle for Heavy Cutting

The use of both cylindrical roller bearings and angular contact bearings provide high speed and rigidity. This enables machining of heavy workpieces. Also, LV8500 Series is with a gear box type spindle (Option), which provides high torque at low rpm and stability at high rpm.



C-Axis Control ('M' Type)

The C-axis is capable of 0.001° control when milling turret is applied. Machining capability is strengthened with turning and milling operations.

2 Step Pressure Chucking Device **OPTION**

The 2 step pressure chucking system enables high pressure chucking during rough cutting and low pressure chucking during precision cutting.

Chip Influx Protection

The LV8500 Series is incorporated with a protection device to keep chips and other foreign materials from entering the main spindle, ensuring long term high precision performance.

Chute Structure

The sloped bed design improves chip flow and disposal of cutting fluids minimizing thermal displacement.

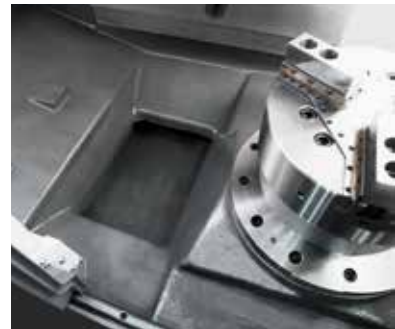

LPS CHUCKING CONFIRMATION

LPS (Linear Position Sensor) **OPTION**

Monitoring the clamping position of the chuck jaw and the status of clamping are possible with LPS.

This easy to use control feature improves safety and convenience during frequent workpiece changes.



03 SERVO TURRET

High speed, High Accuracy, Highly Reliable Servo Turret

Servo Turret

No. of Tools

12_{EA}

Tool Size (O.D/I.D)

□ 32/Ø63 mm (□ 1.3"/Ø2.5")

Indexing Time

0.2_{sec}

Mill Turret

ITEM	Speed	Motor (Max./Cont)	Torque (Max./Cont)	Collet Size
BMT75	4,000 rpm	11/5.5 kW (15/7.4)	140/70 N·m (103.3/51.6 lbf-ft)	ER40 - Ø26 (1")

VARIOUS DRIVEN PRECISION BMT TOOL HOLDERS

TURRET



Std. 12 Station

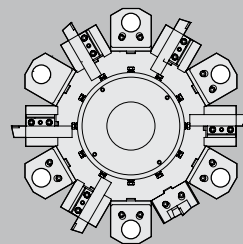

BMT 12 Station

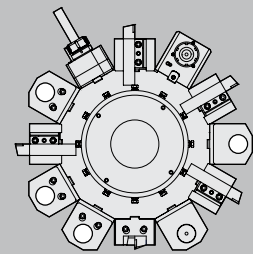

Servo Turret

The LV8500 Series' machining reliability is enhanced by incorporating a high performance AC servo motor to the turret drive mechanism.

Also, the turrets are installed with 3 piece couplings to improve indexing accuracy. Powerful hydraulic tool clamping exhibits great heavy duty machining performance by minimizing tool tip deviation due to work load.

BMT Turret ('M' Type)

The BMT turret secures the tool with four bolts and key on the tool mounting surface of the turret, making it possible to powerfully fix the tool, ensuring high reliability in rigidity and precision.



STRAIGHT MILLING HEAD



ANGULAR MILLING HEAD



Mill Tool Holder

Machining capability has increased with the addition of straight milling head tool holder, which can machine workpieces from the side, and angular milling head tool holder, which can perform I.D. operations.



Special Tool

OPTION

The LV8500 series can process high value-added products using a variety of rotating tools. In particular, there is a multi-holder for attaching a variety of tools to one holder, and an eccentric rotary tool for handling eccentric parts without additional axis travel, which can realize integration of process with one machine.

❖ Consultation needed when ordering these options.

04 HYUNDAI WIA FANUC – SMART PLUS

The Compatible All-round Control



15" Touch-type Monitor as a standard

	Fast Cycle Time Technology
Smart Machine Control	Fine Surface Technology
	Smart Servo Control Technology
Conversational Program	SmartGuide-i
i-HMI	Machining-aid Function
Part Program Storage	5120M (2MB)
No. of Registerable Programs	1000 EA



SMART SOFTWARE



Dialogue Program (Smart Guide-i)

This software offers the maximum user convenience through dialogue manipulation from setup to processing. This includes writing processing programs and simulation checks.

Convenience Function S/W

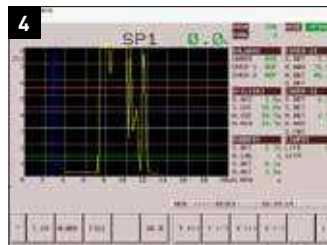

1. Thermal Displacement Compensation (HW-TDC) OPTION
This software improves processing precision by minimizing thermal deformation from changes in external environments and machining.

2. Machine Guidance (HW-MCG)
This software offers various user convenience functions such as tool manipulation, maintenance, tool monitoring, and a pop-up/status

3. LAUNCHER
This software offers shortcuts for quick access to specialized features and frequently used features.

4. Tool Monitoring (HW-TM) OPTION
This tool status monitoring software monitors and protects workpiece, tools, and equipment through real-time monitoring of the motor load from machining.

Machining Support S/W

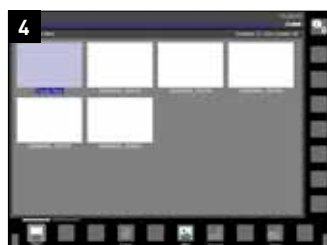
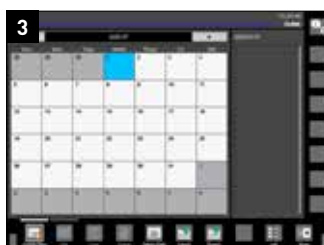

1. Premium Tool Operation
This software offers premium graphic functions for more intuitive tool operation. (Only in iHMI tools)

2. Manual Viewer
This software enables users to view electronic manuals right from the tool. (Only in iHMI tools)

3. Scheduling
This software enables viewing/setting up directly from the tool. This allows such actions as managing customer's tool schedules and schedule notification. (Only in iHMI tools)

4. Operation Memo
This software is capable of managing customer notes such as tool information and issues. (Only in iHMI tools)

SPECIFICATIONS

Standard & Optional

● : Standard ○ : Option ☆ : Prior Consultation - : Non Applicable

Spindle		LV8500R/L	LV8500RM/LM
Belt (37/30/22kW)	A2-11	●	●
Gear Box (45/37/30kW)	A2-11	○	○
Belt (37/30/22kW)	A2-15	○	○
Gear Box (45/37/30kW)	A2-15	○	○
Chuck Size	18"	●	●
	21"	○	○
	24"	○	○
Standard Soft Jaw (1set)		●	●
Chuck Clamp Foot Switch		●	●
2 Steps Hyd. Pressure Device		○	○
5" Index		☆	☆
Cs-Axis (0.001")		-	●
2 Steps Chuck Foot Switch		○	○
Chuck Open/Close Confirmation Device		●	●
Turret			
Tool Holder		●	●
12 station Turret		●	●
Mill Turret	BMT	-	●
Straight Milling Head (Axial)	Collet Type, 1ea	-	●
Angular Milling Head (Radial)	Collet Type, 1ea	-	●
Straight Milling Head	Adapter Type	-	○
Angular Milling Head	Adapter Type	-	○
Boring Sleeve		●	●
Drill Socket		○	○
Angle Head		-	☆
Coolant & Air Blow			
Standard Coolant (Nozzle)		●	●
Bed Flushing Coolant		○	○
Shower Coolant		○	○
Gun Coolant		○	○
Thru Coolant for Live Tool		-	☆
Chuck Air Blow (Upper Chuck)		○	○
Turret Air Blow		☆	☆
Air Gun		○	○
Through Spindle Air Blow (Only for Special Chuck)		☆	☆
High Pressure Coolant	1.5Bar	●	●
	6Bar	○	○
	20Bar	○	○
	70Bar	○	○
Power Coolant System (For Automation)		☆	☆
Coolant Chiller		☆	☆
Chip Disposal			
Coolant Tank	300 ℓ (79.3 gal)	●	●
Chip Conveyor (Hinge/Scraper)	Front (Side)	○	○
	Rear (Rear)	○	○
Special Chip Conveyor (Drum Filter)		☆	☆
Chip Wagon	Standard (180 ℓ [47.5 gal])	○	○
	Swing (200 ℓ [52.8 gal])	○	○
	Large Swing (290 ℓ [76.6 gal])	○	○
	Large Size (330 ℓ [87.2 gal])	○	○
	Customized	☆	☆
Safety Device			
Total Splash Guard		●	●
Chuck hydraulic pressure maintenance interlock		●	●

Electric Device		LV8500R/L	LV8500RM/LM
Call Light	1Color : ●	●	●
Call Light & Buzzer	3Color : ● ■ ■ B	○	○
Electric Cabinet Light		○	○
Remote MPG		○	○
Work Counter	Digital	○	○
Total Counter	Digital	○	○
Tool Counter	Digital	○	○
Multi Tool Counter	Digital	○	○
Electric Circuit Breaker		○	○
AVR (Auto Voltage Regulator)		☆	☆
Transformer	45kVA	○	○
Auto Power Off		○	○
Measurement			
Q-Setter	Removable Type	○	○
Automatic Q-Setter		-	-
Work Close Confirmation Device	TACO	☆	☆
	SMC	☆	☆
Work Setter		☆	☆
Linear Scale	X Axis	○	○
	Z Axis	○	○
Coolant Level Sensor (Only for Chip Conveyor)		☆	☆
Environment			
Air Conditioner		○	○
Oil Mist Collector		☆	☆
Oil Skimmer		○	○
MQL (Minimal Quantity Lubrication)		☆	☆
Fixture & Automation			
Auto Door	Standard	○	○
	High Speed	-	-
Auto Shutter (Only for Automatic System)		-	-
Sub Operation Panel		☆	☆
Extra M-Code 4ea		○	○
Automation Interface		☆	☆
I/O Extension (IN & OUT)	16 Contact	○	○
	32 Contact	○	○
Turret Work Pusher (For Automation)		☆	☆
Hyd. Device			
Standard Hyd. Cylinder	Solid	●	●
	35bar/42 ℓ (11 gal)	-	-
	70bar/24 ℓ (6.3 gal)	●	●
Standard Hyd. Unit	70bar/50 ℓ (13.2 gal)	-	-
S/W			
Conversational program	SmartGuide-i	●	●
	HW-DPRO	○	○
Thermal Displacement Compensation (HW-TDC)		○	○
Tool Monitoring (HW-TM)		○	○
Machine Guidance (HW-MCG)		-	-
Energy Saving System (HW-ESS)		○	○
DNC software (HW-eDNC)		●	●
Machine Monitoring System (HW-MMS)		○	○
Thermal Displacement Compensation Device		○	○
Premium Tool Operation		○	○
Manual Viewer		●	●
Scheduling		●	●
Operation Memo		●	●
ETC			
Tool Box		●	●
Customized Color	Need Munsell No.	☆	☆
CAD & CAM		☆	☆
Special Level Seat	Only with Air Zero	☆	☆

❖ TDC(Thermal Displacement Compensation) device is recommended, when more than 6 bar of high pressure coolant is applied, for the high quality machining.

Prior consultation is required when applying spindle contouring control for gear box driven spindle. / Specifications are subject to change without notice for improvement.

SPECIFICATIONS

Spindle Output/Torque Diagram

18" [21"] [24"] (Belt)

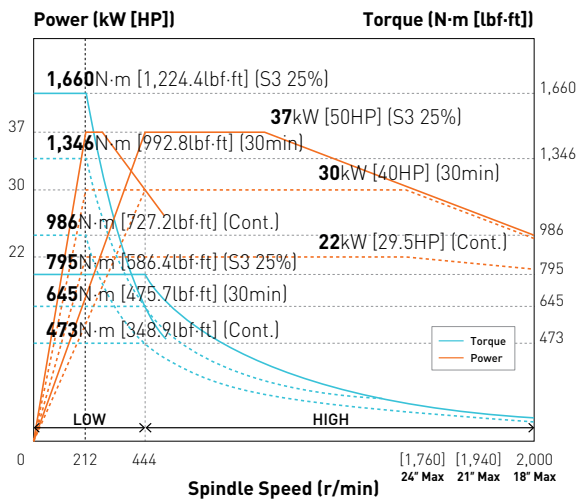

18" [21"] (Gear Box)

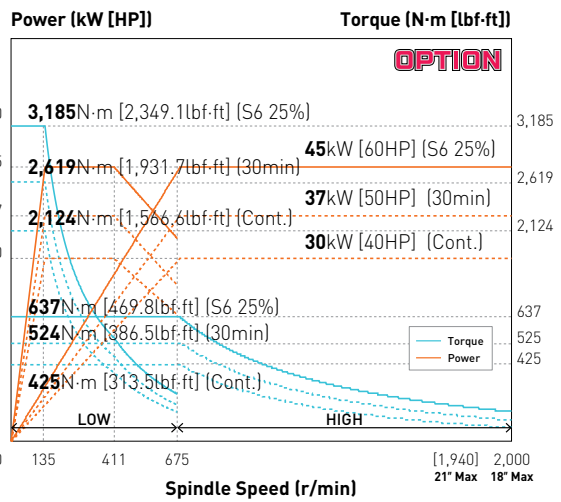

24" (Gear Box)

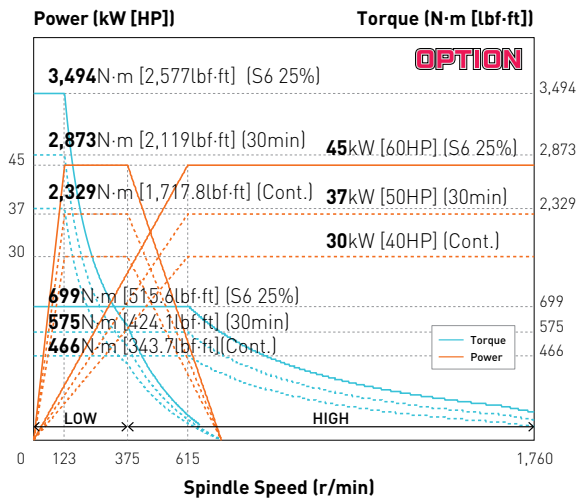

Mill Turret

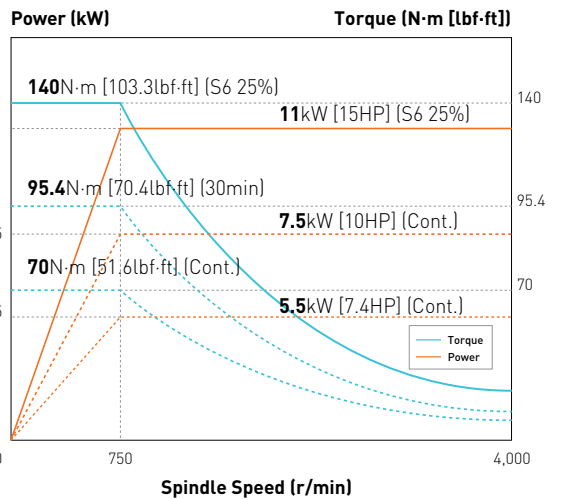

SPECIFICATIONS

External Dimensions

unit : mm(in)

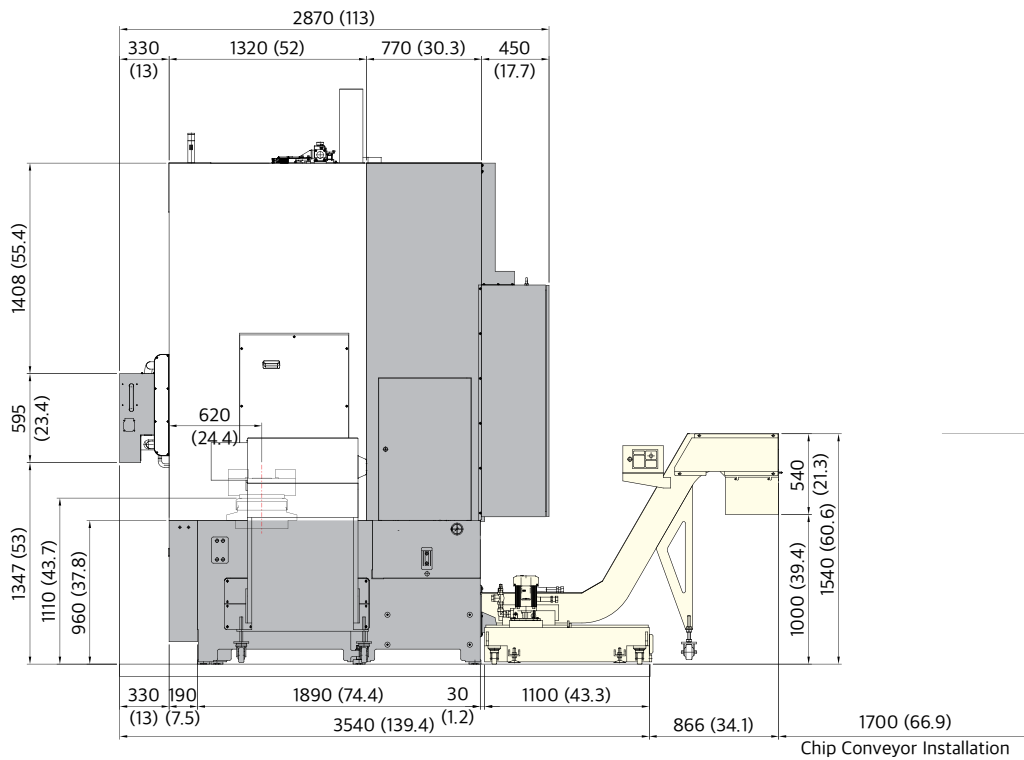
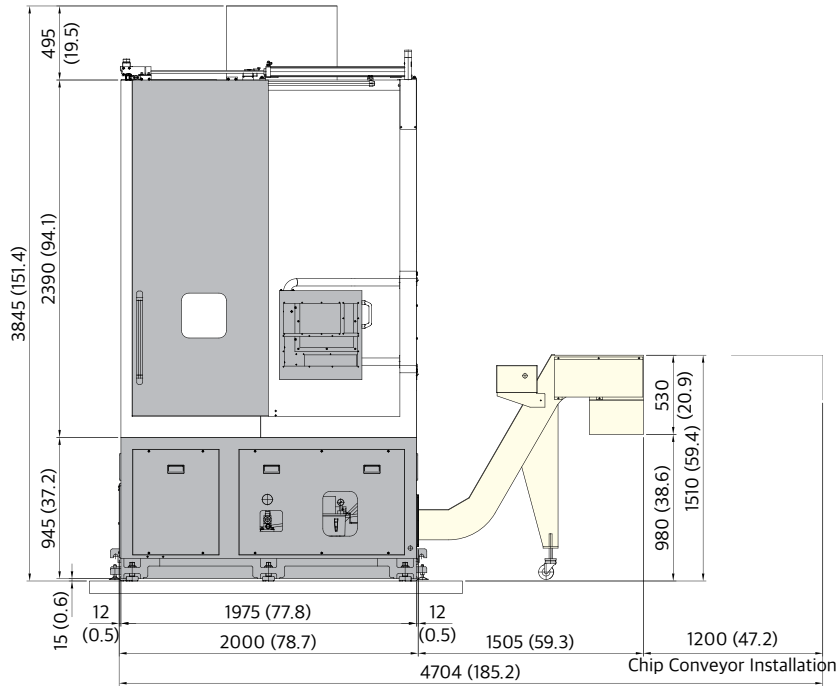

SPECIFICATIONS

Interference

unit : mm(in)

LV8500R/L

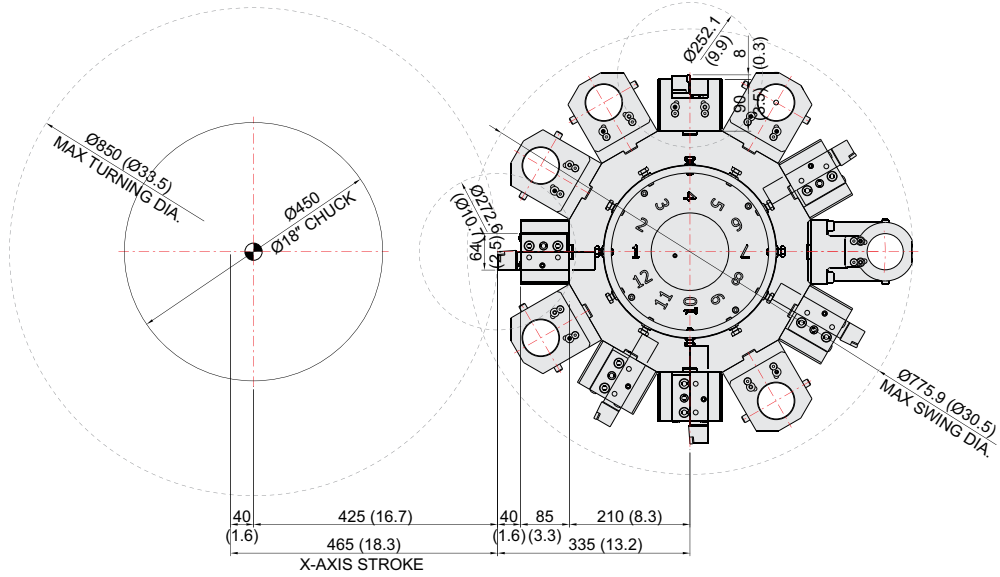

LV8500RM/LM

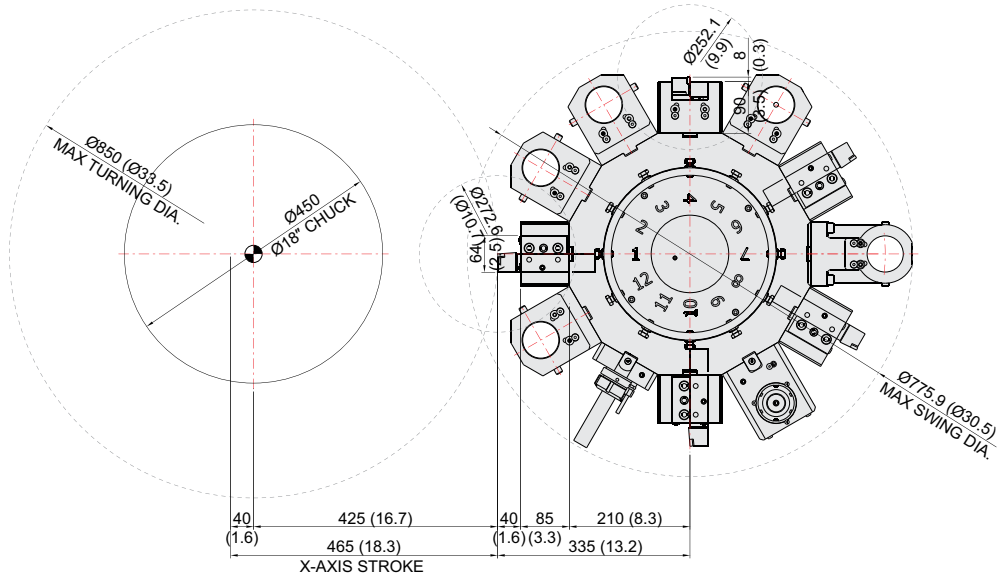

SPECIFICATIONS

Tooling System

unit : mm(in)

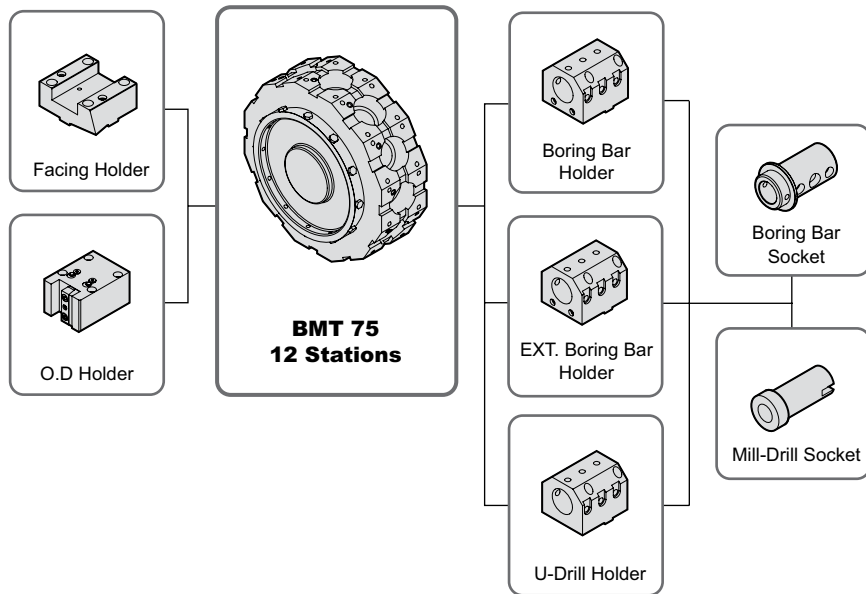

Tooling Parts Detail

ITEM			LV8500R/L	
Turning Holder	O.D Holder	Right/Left	5	
	Facing Holder		1	
Boring Holder	I.D Holder	Single	4	
		Extension	1	
	U-Drill Holder		1	
Driven Holder	Straight Mill Holder	Standard	-	
	Angular Mill Holder	Standard	-	
Socket	Boring	Ø20 (Ø3/4")	1	
		Ø25 (Ø1")	1	
		Ø32 (Ø1 1/4")	1	
		Ø40 (Ø1 1/2")	1	
		Ø50 (Ø2")	1	
	Drill	MT 3		Opt.
		MT 4		Opt.
		MT 5		Opt.

SPECIFICATIONS

Tooling System

unit : mm(in)

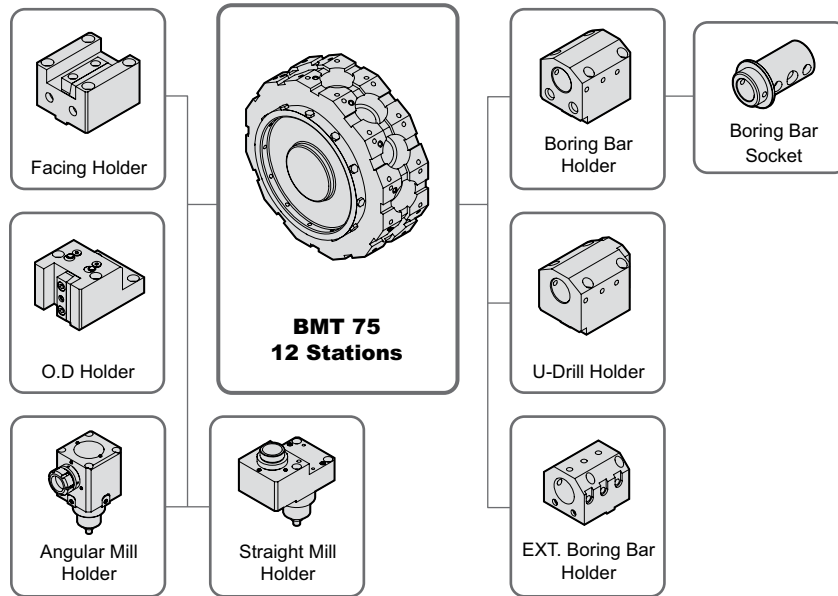

Tooling Parts Detail

ITEM			LV8500RM/LM	
Turning Holder	O.D Holder	Right/Left	4	
	Facing Holder		1	
Boring Holder	I.D Holder	Single	3	
		Extension	1	
	U-Drill Holder		1	
Driven Holder	Straight Mill Holder	Standard	1	
	Angular Mill Holder	Standard	1	
Socket	Boring	Ø20 (Ø3/4")	1	
		Ø25 (Ø1")	1	
		Ø32 (Ø1 1/4")	1	
		Ø40 (Ø1 1/2")	1	
		Ø50 (Ø2")	1	
	Drill	MT 3		Opt.
		MT 4		Opt.
		MT 5		Opt.

Specifications are subject to change without notice for improvement.

SPECIFICATIONS

Tooling Travel Range

unit : mm(in)

LV8500R/L
LV8500RM/LM

O.D.

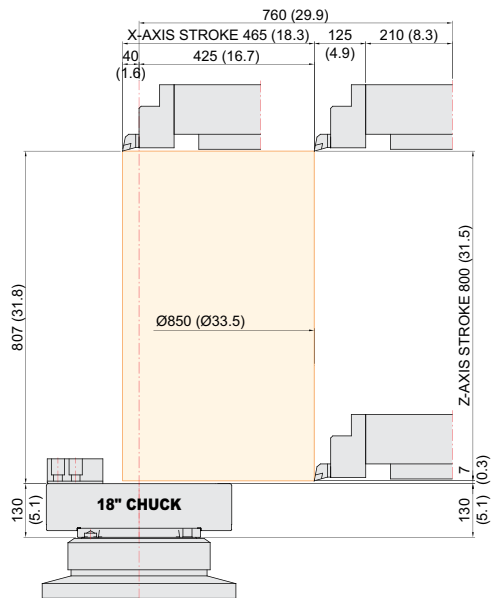

I.D.

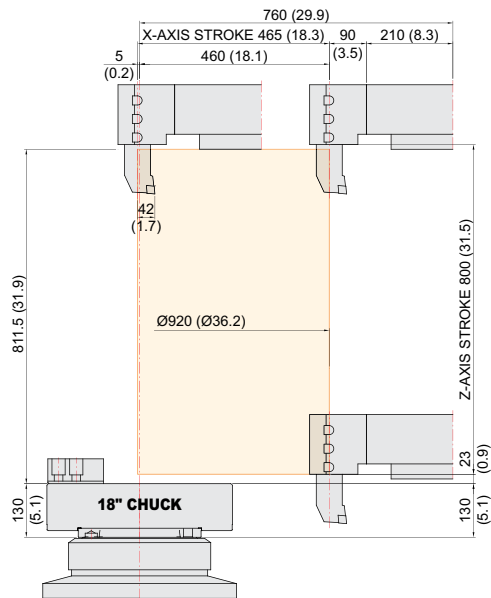

EXTEND I.D.

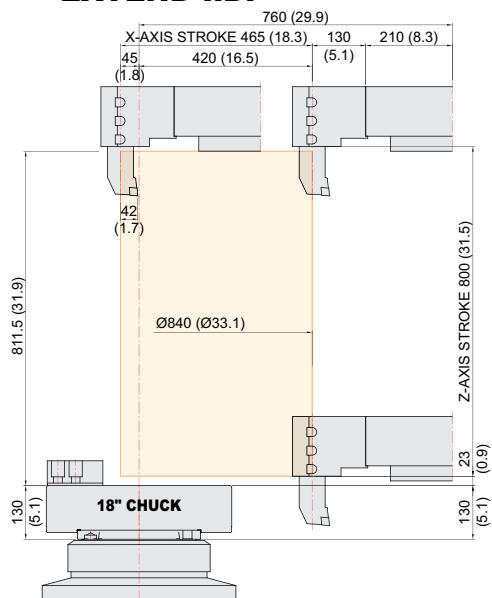

FACING

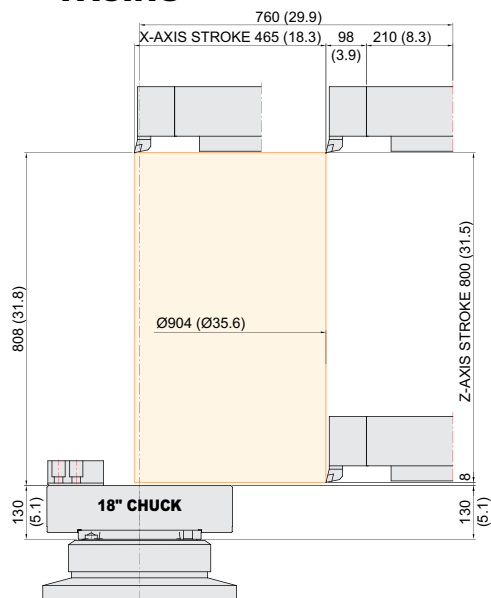

SPECIFICATIONS

Tooling Travel Range

unit : mm(in)

LV8500RM/LM

ANGULAR DRIVEN

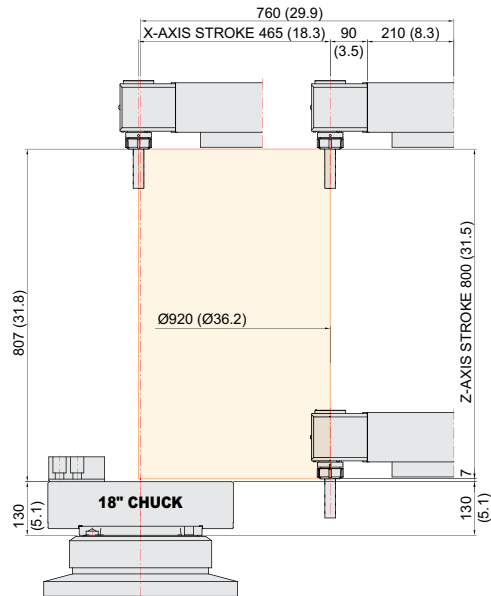

STRAIGHT DRIVEN

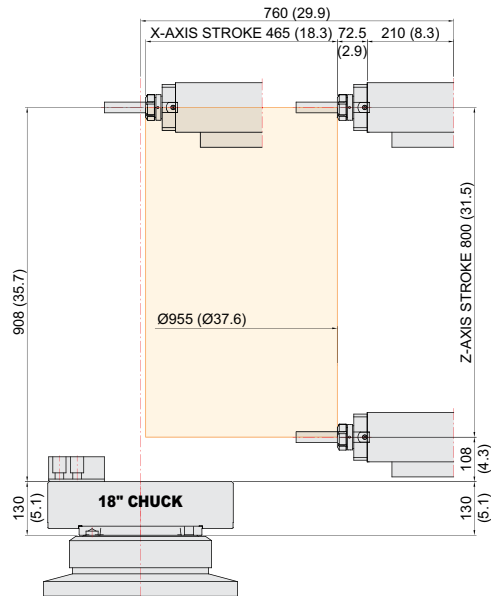

SPECIFICATIONS

Specifications

[] : 선택사양

ITEM			LV8500R/L	LV8500RM/LM
CAPACITY	Swing Over the Bed	mm(in)	Ø890 (Ø35")	
	Swing Over the Carriage	mm(in)	Ø710 (Ø28")	
	Max. Turning Dia.	mm(in)	Ø850 (Ø33.5")	
	Max. Turning Length	mm(in)	800 (31.5")	
FEED	Travel (X/Z)	mm(in)	465/800 (18.3"/31.5")	
	Rapid Traverse Rate (X/Z)	m/min(ipm)	20/20 (787/787)	
	Slide Type	-	BOX GUIDE	
TURRET	No. of Tools	EA	12	
	Tool Size (O.D/I.D)	mm(in)	□ 32/Ø63 (□ 1.3"/Ø2.5")	
	Indexing Time	sec/step	0.2	
LIVE TOOL	Power (Max./30min/Cont.)	kW(HP)	-	11/7.5/5.5 (15/10/7.4)
	Speed(rpm)	r/min	-	4,000
	Torque (Max./30min/Cont.)	N·m(lbf·ft)	-	140/95.4/70 (103.3/70.4/51.6)
	Collet Size	mm(in)	-	Ø26(1") - ER40
	Type	-	-	BMT75
TANK CAPACITY	Coolant Tank	ℓ(gal)	300 (79.3)	
	Lubricating Tank	ℓ(gal)	3 (0.8)	
POWER SUPPLY	Electric Power Supply	kVA	33	37
	Thickness of Power Cable	Sq	Over 35	
	Voltage	V/Hz	220/60 (200/50)	
MACHINE	Floor Space (L×W)	mm(in)	2,000×3,540 (78.7"×139.4")	
	Height	mm(in)	3,845 (151.4")	
	Weight	kg(lb)	9,500 (20,944)	
PC	Controller	-	HYUNDAI WIA FANUC i Series - Smart Plus	

Spindle

Chuck	Spindle Nose	Speed r/min	Power (Max./30min/Cont.)	Torque (Max./30min/Cont.)	Driving Method
18"	A2-11	2,000 rpm	37/30/22 kW (50/40/29.5 HP)	1,660/1,346/986 N·m (1,224.4/992.8/727.2 lbf·ft)	Belt
			[45/37/30 kW] [(60/50/30 HP)]	[3,185/2,619/2,124 N·m] [(2,349.1/1,931.7/1,566.6 lbf·ft)]	[Gear Box]
[21"]	[A2-11]	[1,940 rpm]	[37/30/22 kW] [(50/40/29.5 HP)]	[1,660/1,346/986 N·m] [(1,224.4/992.8/727.2 lbf·ft)]	[Belt]
			[45/37/30 kW] [(60/50/30 HP)]	[3,494/2,873/2,329 N·m] [(2,577/2,119/1,717.8 lbf·ft)]	[Gear Box]
[24"]	[A2-15]	[1,760 rpm]	[37/30/22 kW] [(50/40/29.5 HP)]	[1,660/1,346/986 N·m] [(1,224.4/992.8/727.2 lbf·ft)]	[Belt]
			[45/37/30 kW] [(60/50/30 HP)]	[3,494/2,873/2,329 N·m] [(2,577/2,119/1,717.8 lbf·ft)]	[Gear Box]

* Prior consultation is required when applying spindle contouring control for gear box driven spindle.

CONTROLLER

HYUNDAI WIA FANUC i Series – Smart Plus

[] : Option

Controlled axis / Display / Accuracy Compensation	
Control axes	2 axes (X, Z) / 3 axes (X, Z, C) / 4 axes (X,Z,Y,C) 5 axes (X, Z, B, C, A) / 6 axes (X, Z, Y, B, C, A) 7 axes (X1/Z1, X2/Z2, B2, C1/C2)
Simultaneously controlled axes	2 axes [Max. 4 axes]
Designation of spindle axes	3 axes [Max. 4 axes]
Least setting Unit	X, Z, Y, B axes : 0.001 mm (0.0001 inch) C, A axes : 0.001 deg
Least input increment	X, Z, Y, B axes : 0.001 mm (0.0001 inch) C, A axes : 0.001 deg
Inch / Metric conversion	G20 / G21
High response vector control	
Interlock	All axes / Each axis
Machine lock	All axes
Backlash compensation	± 0~9999 pulses (exc.Rapid traverse / Cutting feed)
Position switch	
LCD / MDI	15 inch LCD unit (with Touch Panel)
Feedback	Absolute motor feedback
Stored stroke check 1	Over travel
Stored stroke check 2, 3	
PMC axis control	
Operation	
Automatic operation (Memory)	
MDI operation	
DNC operation	Needed DNC software / CF card
Program restart	
Wrong operation prevention	
Program check function	Dry run
Single block	
Search function	Program Number / Sequence Number
Interpolation functions	
Nano interpolation	
Positioning	G00
Linear interpolation	G01
Circular interpolation	G02, G03
Exact stop mode	Single : G09, Continuous : G61
Dwell	G04, 0 ~ 9999.9999 sec
Skip	G31
Reference position return	1st reference : G28, 2nd reference : G30 Ref. position check : G27
Thread synchronous cutting	G33
Thread cutting retract	
Variable lead thread cutting	
Multi / Continuous threading	
Feed function / Acc. & Dec. control	
Manual feed	Rapid traverse Jog : 0~2,000 mm/min (79 ipm) Manual handle : x1, x10, x100 pulses Reference position return
Cutting Feed command	Direct input F code
Feedrate override	0 ~ 200% (10% Unit)
Rapid traverse override	1%, F25%, 50%, 100%
Override cancel	
Feed per minute	G98
Feed per revolution	G99
Look-ahead block	1 block
Program input	
Tape Code	EIA / ISO
Optional block skip	1 ea
Absolute / Incremental program	G90 / G91
Program stop / end	M00, M01 / M02, M30
Maximum command unit	± 999,999.999 mm (± 99,999.9999 inch)
Plane selection	X-Y : G17 / Z-X : G18 / Y-Z : G19
Workpiece coordinate system	G52, G53, 6 pairs (G54 ~ G59)
Manual absolute	Fixed ON
Programmable data input	G10
Sub program call	10 folds nested
Custom macro	#100 ~ #199, #500 ~ #999
G code system	A, B/C
Programmable mirror image	G51.1, G50.1
G code preventing buffering	G4.1
Direct drawing dimension program	Including Chamfering / Corner R
Conversational Program	SmartGuide-i

Program input	
Multiple repetitive cycles	I, II
Canned cycle for turning	
Auxiliary function / Spindle speed function	
Auxiliary function	M & 4 digit
Level-up M Code	High speed / Multi / Bypass M code
Spindle speed function	S & 5 digit, Binary output
Spindle override	0% ~ 150% (10% Unit)
Multi position spindle orientation	M19 (S##)
FSSB Rigid tapping	
Constant surface speed control	G96, G97
Tool function / Tool compensation	
Tool function	T & 2 digit + Offset 2 digit
Tool life management	
Tool offset pairs	128 pairs
Tool nose radius compensation	G40, G41, G42
Geometry / Wear compensation	
Direct input of offset measured B	
Editing function	
Part program storage size	5,120m (2MB)
No. of registerable programs	1,000 ea
Program protect	
Background editing	
Extended part program editing	Copy, move and change of NC program
Memory card program edit	
Data input / output & Interface	
I/O interface	CF card, USB memory Embedded Ethernet interface
Screen hard copy	
External message	
External key input	
External workpiece number search	
Automatic data backup	
Setting, display and diagnosis	
Self-diagnosis function	
History display & Operation	Alarm & Operator message & Operation
Run hour / Parts count display	
Maintenance information	
Actual cutting feedrate display	
Display of spindle speed / T code	
Graphic display	
Operating monitor screen	Spindle / Servo load etc.
Power consumption monitoring	Spindle & Servo
Spindle / Servo setting screen	
Multi language display	Support 24 languages
Display language switching	Selection of 5 optional Languages
LCD Screen Saver	Screen saver
Unexpected disturbance torque	BST (Back spin torque limit)
Function for machine type	
Cs contour control (C & A axes)	Mill, MS, Y, SY, LF-Mill, TTMS, TTSY
Polar coordinate interpolation	Mill, MS, Y, SY, LF-Mill, TTMS, TTSY
Cylindrical interpolation	Mill, MS, Y, SY, LF-Mill, TTMS, TTSY
Polygon turning (2 Spindles)	Mill, MS, Y, SY, LF-Mill, TTMS, TTSY
Canned cycle for drilling	Mill, MS, Y, SY, LF-Mill, TTMS, TTSY
Spindle orientation expansion	MS, SY, TTS, TTMS, TTSY
Spindle synchronous control	MS, SY, TTS, TTMS, TTSY
Torque control	MS, SY, TTS, TTMS, TTSY
Y axis offset	Y, SY, TTSY
Arbitrary angular control	Y, SY, TTSY
Composite / Superimposed control	MS, SY, TTS, TTMS, TTSY
Balance cutting	TTS, TTMS, TTSY
Option	
Additional optional block skip	9 ea
Fast ethernet	Needed option board
Data server	Needed option board
Protection of data at 8 levels	
Tool offset pairs	200 pairs
Helical interpolation	
Optional block skip	40 ea, 200 ea (AICC II)

Figures in inch are converted from metric values.

The FANUC controller specifications are subject to change based on the policy of company CNC supplying.



You Tube HYUNDAI WIA MT

www.youtube.com/HYUNDAIWIAMT

EXPERIENCE THE NEW TECHNOLOGY

With its top-quality HYUNDAI WIA machine tool creates a new and better world.



<http://machine.hyundai-wia.com>

HYUNDAI WIA Machine Tools
Global Links

HEADQUARTER

Changwon Technical Center/R&D Center/Factory 153, Jeongdong-ro, Seongsan-gu, Changwon-si, Gyeongsangnam-do, Korea TEL : +82 55 280 9114 FAX : +82 55 282 9114

Overseas Sales Team /R&D Center 37, Cheoldobangmulgwan-ro, Uiwang-si, Gyeonggi-do, Korea TEL : +82 31 8090 2539

OVERSEAS OFFICES

HYUNDAI WIA Machine America corp. 450 Commerce Blvd, Carlstadt, NJ 07072, USA TEL : +1-201-987-7298

HYUNDAI WIA Europe GmbH Alexander-Fleming-Ring 57, 65428 Rüsselsheim Germany TEL : +49-0-6142-9256-0

HYUNDAI WIA Machine Tools China 2-3F, Bldg6, No.1535 Hongmei Road, Xuhui District, Shanghai, China TEL : +86-21-6427-9885

India Branch Office #4/169, 1st Floor, LOTTE BLDG, Rajiv Gandhi Salai, (OMR), Kandanchavadi, Chennai - 600096, Tamilnadu, India TEL : +91-76-0490-3348

Vietnam Branch Office Flat number 05, Service and Trade Center of Viet Huong Industrial Zone, Highway 13, Thuan Giao, Thuan An, Binh Duong, Vietnam TEL : +84-3-5399-5099

2021-03 001.003 ENG