



Hubkrafttabellen ET18



Abb. 1: Hubkrafttabelle
Oberwagen nicht gekippt



Abb. 2: Hubkrafttabelle – Oberwagen gekippt,
Armsystem bergauf (Hangneigung 15°)

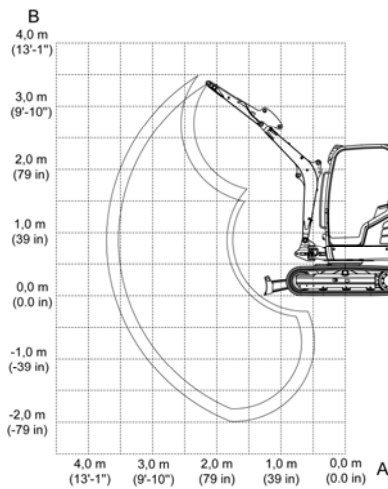

Abb. 3: Hubkrafttabelle – Oberwagen gekippt,
Armsystem bergauf (Hangneigung 15°)

Bezeichnung	Erklärung
A	Ausladung von Drehkranzmitte
B	Lasthakenhöhe
max	Zulässige Gewichts- oder Massewert bei gestrecktem Armsystem
	Mit oder ohne Planierschildabstützung in Fahrtrichtung
	Mit oder ohne Planierschildabstützung 90° zur Fahrtrichtung
	Planierschild unten
	Planierschild oben
	Telefahrwerk ausgefahren

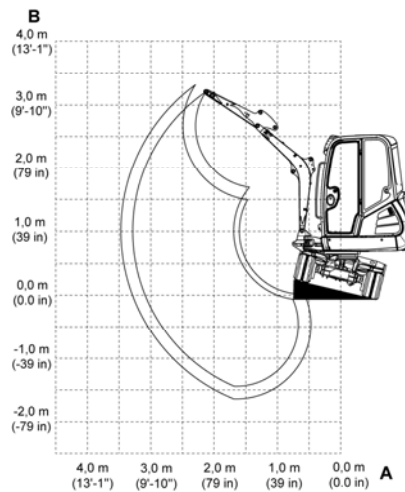
Die Hubkraft des Fahrzeugs ist durch die hydraulische Leistung bzw. durch die Kippsicherheit begrenzt.

Es werden weder 75% der statischen Kipplast noch 87% der hydraulischen Hubkraft überschritten.

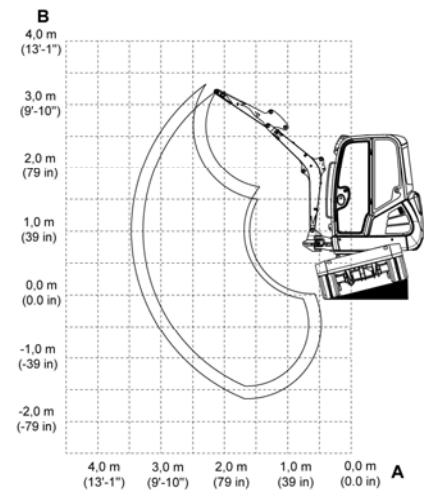
Berechnungsgrundlage: gemäß ISO 10567. Einstelldruck am Hubarmzylinder:

ET 18: 20000 kPa (2900 psi)

















Die Hubfähigkeit gilt für Fahrzeuge unter folgenden Bedingungen:

- Schmier- und Betriebsmittel auf den vorgeschriebenen Ständen.
- Voller Kraftstofftank.
- Kabine oder Canopy.
- Fahrzeug auf Betriebstemperatur.
- Gewicht des Fahrers 75 kg (165 lbs).



















**WACKER
NEUSON**
all it takes!

Hubkrafttabellen ET18 – Oberwagen nicht gekippt

A B				3,0 m (9'-10")			2,5 m (98 in)			2,0 m (79 in)			1,5 m (59m)		
															
2,5 m (98 in)	382 (842)	290 (639)	249 (549)	-	-	-	366 (807)	318 (701)	274 (604)	-	-	-	-	-	-
2,0 m (79 in)	384 (847)	239 (527)	203 (448)	-	-	-	371 (818)	316 (697)	271 (597)	-	-	-	-	-	-
1,0 m (39 in)	402 (886)	201 (443)	169 (373)	423 (933)	228 (503)	193 (425)	492 (1,085)	295 (605)	251 (553)	641 (1,413)	399 (880)	340 (750)	-	-	-
0,0 m (0.0 in)	430 (948)	204 (450)	171 (377)	466 (1,027)	219 (483)	183 (403)	591 (1,303)	277 (611)	233 (514)	814 (1,795)	370 (816)	312 (688)	1257 (2,771)	550 (1,213)	463 (1,021)
-1,0 m (-39 in)	461 (1,016)	263 (580)	222 (489)	-	-	-	507 (1,118)	279 (615)	234 (516)	702 (1,548)	372 (820)	314 (692)	1004 (2,213)	559 (1,232)	473 (1,043)
-1,5 m (-59 in)	460 (1,014)	378 (833)	321 (708)	-	-	-	-	-	-	475 (1,047)	386 (851)	327 (721)	705 (1,554)	575 (1,268)	488 (1,076)

Tab.1: Hubkrafttabellen ET18 Oberwagen nicht gekippt – Kabine und Standardfahrwerk mit kurzem Löffelstiel

















A B				3,0 m (9'-10")			2,5 m (98 in)			2,0 m (79 in)			1,5 m (59m)		
															
2,5 m (98 in)	341 (752)	252 (556)	215 (474)	-	-	-	304 (670)	304 (670)	276 (609)	-	-	-	-	-	-
2,0 m (79 in)	346 (763)	213 (470)	180 (397)	335 (739)	237 (523)	201 (443)	318 (701)	316 (697)	272 (600)	-	-	-	-	-	-
1,0 m (39 in)	365 (805)	181 (399)	151 (333)	392 (864)	225 (496)	190 (419)	448 (988)	294 (648)	249 (549)	567 (1,250)	401 (884)	343 (756)	-	-	-
0,0 m (0.0 in)	393 (866)	183 (403)	152 (335)	454 (1,001)	213 (470)	178 (392)	573 (1,263)	272 (600)	228 (503)	793 (1,748)	364 (803)	306 (675)	1271 (2,802)	539 (1,188)	453 (999)
-1,0 m (-39 in)	426 (939)	227 (500)	189 (417)	-	-	-	541 (1,193)	268 (591)	224 (494)	740 (1,631)	361 (796)	303 (668)	1089 (2,401)	544 (1,199)	457 (1,008)
-1,5 m (-59 in)	440 (970)	299 (659)	252 (556)	-	-	-	-	-	-	586 (1,292)	370 (816)	312 (688)	851 (1,876)	557 (1,228)	470 (1,036)

Tab.2: Hubkrafttabellen ET18 Oberwagen nicht gekippt – Kabine und Standardfahrwerk mit langem Löffelstiel



















**WACKER
NEUSON**
all it takes!

Hubkrafttabellen ET18 – Oberwagen nicht gekippt

A B				3,0 m (9'-10")			2,5 m (98 in)			2,0 m (79 in)			1,5 m (59m)		
															
2,5 m (98 in)	382 (842)	382 (842)	313 (690)	-	-	-	366 (807)	366 (807)	344 (758)	-	-	-	-	-	-
2,0 m (79 in)	384 (847)	352 (776)	258 (569)	-	-	-	371 (818)	371 (818)	341 (752)	-	-	-	-	-	-
1,0 m (39 in)	402 (886)	299 (659)	217 (478)	423 (933)	340 (750)	247 (545)	492 (1,085)	440 (970)	320 (706)	641 (1,413)	607 (1,338)	435 (959)	-	-	-
0,0 m (0.0 in)	430 (948)	306 (675)	221 (487)	466 (1,027)	330 (728)	237 (522)	591 (1,303)	421 (928)	302 (666)	814 (1,795)	575 (1,268)	406 (895)	1257 (2,771)	894 (1,971)	611 (1,347)
-1,0 m (-39 in)	461 (1,016)	398 (877)	286 (631)	-	-	-	507 (1,118)	423 (933)	303 (668)	702 (1,548)	577 (1,272)	408 (899)	1004 (2,213)	905 (1,995)	621 (1,369)
-1,5 m (-59 in)	460 (1,014)	460 (1,014)	413 (911)	-	-	-	-	-	-	475 (1,047)	475 (1,047)	422 (930)	705 (1,554)	705 (1,554)	637 (1,404)

Tab.3: Hubkrafttabellen ET18 Oberwagen nicht gekippt – Kabine und Telefahrwerk mit kurzem Löffelstiel

















A B				3,0 m (9'-10")			2,5 m (98 in)			2,0 m (79 in)			1,5 m (59m)		
															
2,5 m (98 in)	341 (752)	341 (752)	273 (602)	-	-	-	304 (670)	304 (670)	304 (670)	-	-	-	-	-	-
2,0 m (79 in)	346 (763)	316 (697)	230 (507)	335 (739)	335 (739)	256 (564)	318 (701)	318 (701)	318 (701)	-	-	-	-	-	-
1,0 m (39 in)	365 (805)	273 (602)	196 (432)	392 (864)	337 (743)	244 (538)	448 (988)	439 (968)	319 (703)	567 (1,250)	567 (1,250)	438 (966)	-	-	-
0,0 m (0.0 in)	393 (866)	277 (611)	198 (437)	454 (1,001)	324 (714)	232 (511)	573 (1,263)	416 (917)	296 (653)	793 (1,748)	569 (1,254)	400 (882)	1271 (2,802)	883 (1,947)	600 (1,323)
-1,0 m (-39 in)	426 (939)	345 (761)	247 (545)	-	-	-	541 (1,193)	412 (908)	293 (646)	740 (1,631)	566 (1,248)	397 (876)	1089 (2,401)	889 (1,960)	606 (1,336)
-1,5 m (-59 in)	440 (970)	440 (970)	326 (719)	-	-	-	-	-	-	586 (1,292)	575 (1,268)	406 (895)	851 (1,876)	851 (1,876)	619 (1,365)

Tab.4: Hubkrafttabellen ET18 Oberwagen nicht gekippt – Kabine und Telefahrwerk mit langem Löffelstiel



















**WACKER
NEUSON**
all it takes!

Hubkrafttabellen ET18 – Oberwagen nicht gekippt

A B				3,0 m (9'-10")			2,5 m (98 in)			2,0 m (79 in)			1,5 m (59m)		
															
2,5 m (98 in)	381 (840)	381 (840)	282 (622)	-	-	-	362 (798)	362 (798)	328 (723)	-	-	-	-	-	-
2,0 m (79 in)	385 (849)	377 (831)	236 (520)	383 (844)	383 (844)	241 (531)	379 (836)	379 (836)	324 (714)	-	-	-	-	-	-
1,0 m (39 in)	405 (893)	329 (725)	202 (445)	430 (948)	374 (825)	231 (509)	507 (1,118)	483 (1,065)	301 (664)	673 (1,484)	663 (1,462)	414 (913)	-	-	-
0,0 m (0.0 in)	434 (957)	344 (758)	209 (461)	465 (1,025)	365 (805)	222 (489)	594 (1,310)	465 (1,025)	284 (626)	816 (1,799)	636 (1,402)	387 (853)	1243 (2,740)	993 (2,189)	598 (1,318)
-1,0 m (-39 in)	464 (1,023)	464 (1,023)	286 (631)	-	-	-	472 (1,041)	470 (1,036)	289 (637)	671 (1,479)	641 (1,413)	392 (864)	956 (2,108)	956 (2,108)	611 (1,347)
-1,5 m (-59 in)	451 (994)	451 (994)	451 (994)	-	-	-	-	-	-	-	-	-	607 (1,338)	607 (1,338)	607 (1,338)

Tab.5: Hubkrafttabellen ET18 Oberwagen nicht gekippt – Kabine, Telefahwerk und VDS mit kurzem Löffelstiel

















A B				3,0 m (9'-10")			2,5 m (98 in)			2,0 m (79 in)			1,5 m (59m)		
															
2,5 m (98 in)	341 (752)	341 (752)	246 (542)	-	-	-	303 (668)	303 (668)	303 (668)	-	-	-	-	-	-
2,0 m (79 in)	347 (765)	340 (750)	210 (463)	337 (743)	337 (743)	241 (531)	327 (721)	327 (721)	325 (717)	-	-	-	-	-	-
1,0 m (39 in)	367 (809)	301 (664)	182 (401)	400 (882)	371 (818)	228 (503)	466 (1,027)	466 (1,027)	300 (661)	603 (1,329)	603 (1,329)	416 (917)	-	-	-
0,0 m (0.0 in)	396 (873)	311 (686)	186 (410)	457 (1,008)	359 (791)	216 (476)	579 (1,276)	460 (1,014)	278 (613)	800 (1,764)	629 (1,387)	380 (838)	1268 (2,795)	981 (2,163)	586 (1,292)
-1,0 m (-39 in)	430 (948)	400 (882)	242 (534)	-	-	-	522 (1,151)	459 (1,012)	277 (611)	718 (1,583)	629 (1,387)	380 (838)	1050 (2,315)	990 (2,183)	595 (1,312)
-1,5 m (-59 in)	441 (972)	441 (972)	341 (752)	-	-	-	-	-	-	531 (1,171)	531 (1,171)	392 (864)	779 (1,717)	779 (1,717)	611 (1,347)

Tab.6: Hubkrafttabellen ET18 Oberwagen nicht gekippt – Kabine, Telefahwerk und VDS mit langem Löffelstiel



















**WACKER
NEUSON**
all it takes!

Hubkrafttabellen ET18 – Oberwagen nicht gekippt

A B				3,0 m (9'-10")			2,5 m (98 in)			2,0 m (79 in)			1,5 m (59m)		
															
2,5 m (98 in)	382 (842)	268 (591)	227 (500)	-	-	-	366 (807)	294 (648)	251 (553)	-	-	-	-	-	-
2,0 m (79 in)	384 (847)	220 (485)	184 (406)	-	-	-	371 (818)	292 (644)	248 (547)	-	-	-	-	-	-
1,0 m (39 in)	402 (886)	183 (403)	152 (335)	423 (933)	209 (461)	174 (384)	492 (1,085)	271 (597)	227 (500)	641 (1,413)	368 (811)	310 (683)	-	-	-
0,0 m (0.0 in)	430 (948)	186 (410)	153 (337)	466 (1,027)	200 (441)	165 (364)	591 (1,303)	253 (558)	210 (463)	814 (1,795)	339 (747)	281 (619)	1257 (2,771)	504 (1,111)	419 (924)
-1,0 m (-39 in)	461 (1,016)	241 (531)	200 (441)	-	-	-	507 (1,118)	255 (562)	211 (465)	702 (1,548)	341 (752)	283 (624)	1004 (2,213)	514 (1,133)	428 (944)
-1,5 m (-59 in)	460 (1,014)	347 (765)	291 (642)	-	-	-	-	-	-	475 (1,047)	354 (780)	296 (653)	705 (1,554)	529 (1,166)	444 (979)

Tab.7: Hubkrafttabellen ET18 Oberwagen nicht gekippt – Canopy und Standardfahrwerk mit kurzem Löffelstiel

















A B				3,0 m (9'-10")			2,5 m (98 in)			2,0 m (79 in)			1,5 m (59m)		
															
2,5 m (98 in)	341 (752)	232 (511)	196 (432)	-	-	-	304 (670)	297 (655)	253 (558)	-	-	-	-	-	-
2,0 m (79 in)	346 (763)	195 (430)	163 (359)	335 (739)	218 (481)	183 (403)	318 (701)	293 (646)	249 (549)	-	-	-	-	-	-
1,0 m (39 in)	365 (805)	165 (364)	135 (298)	392 (864)	206 (454)	171 (377)	448 (988)	270 (595)	226 (498)	567 (1,250)	370 (816)	312 (688)	-	-	-
0,0 m (0.0 in)	393 (866)	166 (366)	135 (298)	454 (1,001)	194 (428)	159 (351)	573 (1,263)	248 (547)	204 (450)	793 (1,748)	333 (734)	275 (606)	1271 (2,802)	494 (1,089)	408 (899)
-1,0 m (-39 in)	426 (939)	206 (454)	169 (373)	-	-	-	541 (1,193)	245 (540)	201 (443)	740 (1,631)	330 (728)	272 (600)	1089 (2,401)	498 (1,098)	413 (911)
-1,5 m (-59 in)	440 (970)	274 (604)	227 (500)	-	-	-	-	-	-	586 (1,292)	339 (747)	281 (619)	851 (1,876)	511 (1,127)	425 (937)

Tab.8: Hubkrafttabellen ET18 Oberwagen nicht gekippt – Canopy und Standardfahrwerk mit langem Löffelstiel



















**WACKER
NEUSON**
all it takes!

Hubkrafttabellen ET18 – Oberwagen nicht gekippt

A B				3,0 m (9'-10")			2,5 m (98 in)			2,0 m (79 in)			1,5 m (59m)		
															
2,5 m (98 in)	382 (842)	382 (842)	289 (637)	-	-	-	366 (807)	366 (807)	317 (699)	-	-	-	-	-	-
2,0 m (79 in)	384 (847)	326 (719)	237 (522)	-	-	-	371 (818)	371 (818)	315 (694)	-	-	-	-	-	-
1,0 m (39 in)	402 (886)	276 (608)	198 (437)	423 (933)	314 (692)	226 (498)	492 (1,085)	408 (899)	294 (648)	641 (1,413)	563 (1,241)	400 (882)	-	-	-
0,0 m (0.0 in)	430 (948)	282 (622)	201 (443)	466 (1,027)	304 (670)	216 (476)	591 (1,303)	389 (858)	275 (606)	814 (1,795)	531 (1,171)	371 (818)	1257 (2,771)	827 (1,823)	559 (1,232)
-1,0 m (-39 in)	461 (1,016)	368 (811)	261 (575)	-	-	-	507 (1,118)	390 (860)	277 (611)	702 (1,548)	533 (1,175)	373 (822)	1004 (2,213)	838 (1,847)	569 (1,254)
-1,5 m (-59 in)	460 (1,014)	460 (1,014)	379 (836)	-	-	-	-	-	-	475 (1,047)	475 (1,047)	387 (853)	705 (1,554)	705 (1,554)	586 (1,292)

Tab.9: Hubkrafttabellen ET18 Oberwagen nicht gekippt – Canopy und Telefahrwerk mit kurzem Löffelstiel

















A B				3,0 m (9'-10")			2,5 m (98 in)			2,0 m (79 in)			1,5 m (59m)		
															
2,5 m (98 in)	341 (752)	341 (752)	251 (553)	-	-	-	304 (670)	304 (670)	304 (670)	-	-	-	-	-	-
2,0 m (79 in)	346 (763)	292 (644)	211 (465)	335 (739)	324 (714)	235 (518)	318 (701)	318 (701)	316 (697)	-	-	-	-	-	-
1,0 m (39 in)	365 (805)	251 (553)	179 (395)	392 (864)	311 (686)	223 (492)	448 (988)	407 (897)	292 (644)	567 (1,250)	566 (1,248)	403 (888)	-	-	-
0,0 m (0.0 in)	393 (866)	255 (562)	180 (397)	454 (1,001)	298 (657)	210 (463)	573 (1,263)	383 (844)	270 (595)	793 (1,748)	525 (1,157)	365 (805)	1271 (2,802)	816 (1,799)	549 (1,210)
-1,0 m (-39 in)	426 (939)	318 (701)	224 (494)	-	-	-	541 (1,193)	380 (838)	267 (589)	740 (1,631)	522 (1,151)	362 (798)	1089 (2,401)	822 (1,812)	554 (1,221)
-1,5 m (-59 in)	440 (970)	422 (930)	298 (657)	-	-	-	-	-	-	586 (1,292)	532 (1,173)	371 (818)	851 (1,877)	837 (1,845)	567 (1,250)

Tab.10: Hubkrafttabellen ET18 Oberwagen nicht gekippt – Canopy und Telefahrwerk mit langem Löffelstiel



















**WACKER
NEUSON**
all it takes!

Hubkrafttabellen ET18 – Oberwagen nicht gekippt

A B				3,0 m (9'-10")			2,5 m (98 in)			2,0 m (79 in)			1,5 m (59m)		
															
2,5 m (98 in)	381 (840)	381 (840)	256 (564)	-	-	-	362 (798)	362 (798)	298 (657)	-	-	-	-	-	-
2,0 m (79 in)	385 (849)	351 (774)	212 (467)	383 (844)	358 (789)	217 (478)	379 (836)	379 (836)	294 (648)	-	-	-	-	-	-
1,0 m (39 in)	405 (893)	306 (675)	180 (397)	430 (948)	348 (767)	207 (456)	507 (1,118)	450 (992)	271 (597)	673 (1,484)	619 (1,365)	374 (825)	-	-	-
0,0 m (0.0 in)	434 (957)	319 (703)	186 (410)	465 (1,025)	339 (747)	198 (437)	594 (1,310)	433 (955)	254 (560)	816 (1,799)	591 (1,303)	347 (765)	1243 (2,740)	924 (2,037)	537 (1,184)
-1,0 m (-39 in)	464 (1,023)	433 (955)	256 (564)	-	-	-	472 (1,041)	437 (963)	259 (571)	671 (1,479)	597 (1,316)	352 (776)	956 (2,108)	938 (2,068)	550 (1,213)
-1,5 m (-59 in)	451 (994)	451 (994)	415 (915)	-	-	-	-	-	-	-	-	-	607 (1,338)	607 (1,338)	571 (1,259)

Tab.11: Hubkrafttabellen ET18 Oberwagen nicht gekippt – Canopy, Telefahrwerk und VDS mit kurzem Löffelstiel





















A B				3,0 m (9'-10")			2,5 m (98 in)			2,0 m (79 in)			1,5 m (59m)		
															
2,5 m (98 in)	341 (752)	341 (752)	222 (489)	-	-	-	303 (668)	303 (668)	301 (664)	-	-	-	-	-	-
2,0 m (79 in)	347 (765)	316 (697)	189 (417)	337 (743)	337 (743)	217 (478)	327 (721)	327 (721)	295 (650)	-	-	-	-	-	-
1,0 m (39 in)	367 (809)	279 (615)	161 (355)	400 (882)	345 (761)	204 (450)	466 (1,027)	449 (990)	270 (595)	603 (1,329)	603 (1,329)	376 (829)	-	-	-
0,0 m (0.0 in)	396 (873)	289 (637)	165 (364)	457 (1,008)	333 (734)	192 (423)	579 (1,276)	427 (941)	248 (547)	800 (1,764)	585 (1,290)	340 (750)	1268 (2,795)	912 (2,011)	525 (1,157)
-1,0 m (-39 in)	430 (948)	372 (820)	216 (476)	-	-	-	522 (1,151)	426 (939)	247 (545)	718 (1,583)	585 (1,290)	340 (750)	1050 (2,315)	921 (2,030)	534 (1,177)
-1,5 m (-59 in)	441 (972)	441 (972)	306 (675)	-	-	-	-	-	-	531 (1,171)	531 (1,171)	352 (776)	779 (1,717)	779 (1,717)	551 (1,215)

Tab.12: Hubkrafttabellen ET18 Oberwagen nicht gekippt – Canopy und Telefahrwerk mit langem Löffelstiel























**WACKER
NEUSON**
all it takes!

Hubkrafttabellen ET18 – Oberwagen gekippt

A \ B			3,0 m (9'-10")		2,5 m (98 in)		2,0 m (79 in)		1,5 m (59 in)	
	kurzer Löffelstiel	langer Löffelstiel	kurzer Löffelstiel	langer Löffelstiel	kurzer Löffelstiel	langer Löffelstiel	kurzer Löffelstiel	langer Löffelstiel	kurzer Löffelstiel	langer Löffelstiel
										
										
2,5 m (98 in)	382 (841)	343 (756)	-	336 (741)	361 (796)	306 (675)	-	-	-	-
2,0 m (79 in)	357 (787)	323 (712)	377 (831)	343 (756)	394 (867)	344 (758)	-	-	-	-
1,0 m (39 in)	322 (710)	394 (868)	365 (805)	362 (798)	471 (1,038)	469 (1,034)	644 (1,420)	645 (1,422)	-	-
0,0 m (0.0 in)	347 (765)	313 (690)	358 (789)	351 (774)	456 (1,005)	450 (992)	623 (1,374)	616 (1,358)	974 (2,147)	961 (2,119)
-1,0 m (-39 in)	466 (1,027)	427 (941)	-	-	-	453 (999)	608 (1,340)	620 (1,366)	866 (1,909)	975 (2,150)
-1,5 m (-59 in)	-	437 (963)	-	-	-	-	-	-	-	634 (1,398)

Tab.13: Hubkrafttabellen ET18 Oberwagen gekippt, – VDS, Kabine, Armsystem bergauf

A \ B			3,0 m (9'-10")		2,5 m (98 in)		2,0 m (79 in)		1,5 m (59 in)	
	kurzer Löffelstiel	langer Löffelstiel	kurzer Löffelstiel	langer Löffelstiel	kurzer Löffelstiel	langer Löffelstiel	kurzer Löffelstiel	langer Löffelstiel	kurzer Löffelstiel	langer Löffelstiel
										
										
2,5 m (98 in)	297 (655)	264 (582)	-	275 (606)	361 (796)	306 (675)	-	-	-	-
2,0 m (79 in)	258 (569)	232 (512)	273 (602)	272 (600)	360 (794)	344 (758)	-	-	-	-
1,0 m (39 in)	231 (509)	209 (460)	262 (578)	258 (569)	337 (743)	334 (736)	455 (1,003)	456 (1,056)	-	-
0,0 m (0.0 in)	247 (545)	221 (487)	255 (562)	248 (547)	323 (712)	316 (697)	435 (959)	428 (944)	661 (1,457)	648 (1,428)
-1,0 m (-39 in)	361 (796)	302 (666)	-	-	-	320 (706)	445 (981)	432 (952)	678 (1,495)	661 (1,457)
-1,5 m (-59 in)	-	437 (963)	-	-	-	-	-	-	-	634 (1,398)

Tab.14: Hubkrafttabellen ET18 Oberwagen gekippt, – VDS, Kabine, Armsystem bergab



**WACKER
NEUSON**
all it takes!

Hubkrafttabellen ET18 – Oberwagen gekippt

A \ B			3,0 m (9'-10")		2,5 m (98 in)		2,0 m (79 in)		1,5 m (59 in)	
	kurzer Löffelstiel	langer Löffelstiel	kurzer Löffelstiel	langer Löffelstiel	kurzer Löffelstiel	langer Löffelstiel	kurzer Löffelstiel	langer Löffelstiel	kurzer Löffelstiel	langer Löffelstiel
2,5 m (98 in)	382 (841)	339 (747)	-	336 (741)	361 (796)	306 (675)	-	-	-	-
2,0 m (79 in)	332 (732)	300 (661)	351 (774)	343 (756)	394 (869)	344 (758)	-	-	-	-
1,0 m (39 in)	299 (690)	372 (820)	339 (747)	336 (741)	438 (966)	436 (961)	600 (1,323)	601 (1,325)	-	-
0,0 m (0.0 in)	322 (710)	290 (639)	332 (732)	325 (718)	423 (933)	417 (919)	579 (1,277)	572 (1,261)	906 (1,997)	893 (1,969)
-1,0 m (-39 in)	466 (1,027)	396 (873)	-	-	-	421 (928)	589 (1,299)	576 (1,270)	866 (1,909)	907 (2,000)
-1,5 m (-59 in)	-	437 (963)	-	-	-	-	-	-	-	634 (1,398)

Tab.15: Hubkrafttabellen ET18 Oberwagen gekippt, – VDS, Canopy, Armsystem bergauf

A \ B			3,0 m (9'-10")		2,5 m (98 in)		2,0 m (79 in)		1,5 m (59 in)	
	kurzer Löffelstiel	langer Löffelstiel	kurzer Löffelstiel	langer Löffelstiel	kurzer Löffelstiel	langer Löffelstiel	kurzer Löffelstiel	langer Löffelstiel	kurzer Löffelstiel	langer Löffelstiel
2,5 m (98 in)	274 (604)	243 (536)	-	253 (558)	340 (750)	306 (675)	-	-	-	-
2,0 m (79 in)	237 (523)	213 (470)	251 (553)	250 (551)	333 (734)	333 (734)	-	-	-	-
1,0 m (39 in)	211 (465)	191 (421)	240 (529)	237 (522)	309 (681)	307 (677)	419 (924)	420 (926)	-	-
0,0 m (0.0 in)	226 (498)	202 (445)	233 (514)	226 (498)	296 (653)	289 (637)	399 (880)	392 (864)	608 (1,340)	595 (1,312)
-1,0 m (-39 in)	332 (732)	277 (611)	-	-	-	293 (646)	409 (902)	396 (873)	624 (1,376)	608 (1,340)
-1,5 m (-59 in)	-	435 (959)	-	-	-	-	-	-	-	628 (1,385)

Tab.16: Hubkrafttabellen ET18 Oberwagen gekippt, – VDS, Canopy, Armsystem bergab