

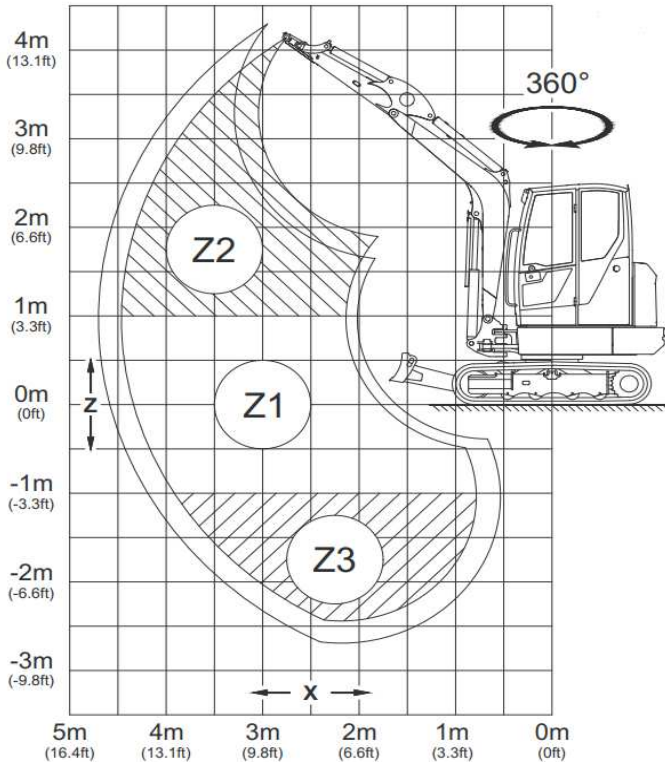

## Hubkrafttabellen ET35



Alle Tabellenwerte sind in kg (lbs) angegeben, bei waagrechtter Stellung auf festem Untergrund und ohne Löffel.

Sofern ein Löffel oder sonstige Arbeitsgeräte angebaut sind, verringert sich die Hubkraft oder Kipplast um deren Eigengewicht.



Berechnungsgrundlage: gemäß ISO 10567

Die Hubkraft des Baggers ist durch die Einstellung der Überdruckventile und durch die Kippsicherheit begrenzt.

Es werden weder 75% der statischen Kipplast noch 87% der hydraulischen Hubkraft überschritten.

Die Hubkraft gilt für Fahrzeuge unter folgenden Bedingungen:

- Schmier- und Betriebsmittel auf den vorgeschriebenen Ständen
- Voller Kraftstofftank
- Kabine
- Fahrzeug auf Betriebstemperatur
- Gewicht des Fahrers 75kg (165lbs)

max	Zulässige Last bei gestrecktem Löffelstiel
A	Ausladung von mitte Drehkranz
B	Lasthakenhöhe
*	Hubkraft durch Hydraulik begrenzt
	Mit bzw. ohne Planierschildabstützung in Fahrtrichtung
	Ohne Planierschildabstützung 90° zur Fahrtrichtung



**Hubkrafttabellen ET35**

					4,0 m (13'-1")			3,0 m (9'-10")			2,0 m (6'-7")		
A	B												
		Schild Unten	Schild oben	Schild oben	Schild Unten	Schild oben	Schild oben	Schild Unten	Schild oben	Schild oben	Schild Unten	Schild oben	Schild oben
4,0 m (13'-1")		738* (1.627)*	738* (1.627)*	738* (1.627)*	-	-	-	-	-	-	-	-	-
3,0 m (9'-10")		738* (1.626)*	577 (1.272)	624 (1.376)	-	-	-	654* (1.443)*	654* (1.443)*	654* (1.443)*	-	-	-
2,0 m (6'-7")		761* (1.677)*	478 (1.054)	517 (1.140)	758* (1.672)*	541 (1.193)	586 (1.291)	829* (1.828)*	829* (1.828)*	829* (1.828)*	1.065* (2.348)*	1.065* (2.348)*	1.065* (2.348)*
1,0 m (3'-3")		794* (1.752)*	444 (980)	481 (1.061)	851* (1.875)*	522 (1.151)	566 (1.248)	1.108* (2.443)*	787 (1.735)	859 (1.895)	2.041* (4.500)*	1.411 (3.112)	1.582 (3.487)
0,0 m (0'-0")		835* (1.841)*	454 (1.001)	492 (1.086)	920* (2.028)*	507 (1.117)	550 (1.213)	1.292* (2.848)*	750 (1.654)	822 (1.812)	2.233* (4.923)*	1.363 (3.005)	1.530 (3.374)
- 1,0 m (-3'-3")		877* (1.934)*	521 (1.148)	566 (1.247)	-	-	-	1.276* (2.814)*	742 (1.636)	813 (1.792)	2.042* (4.502)*	1.369 (3.018)	1.536 (3.388)
- 2,0 m (-6'-7")		886* (1.953)*	754 (1.662)	824 (1.817)	-	-	-	912* (2.011)*	766 (1.690)	838 (1.848)	1.510* (3.330)*	1.406 (3.100)	1.510* (3.330)*

Tab.1: Hubkrafttabelle ET35-STD ohne Zusatzgewicht, Gummikette, kurzer Löffelstiel

					4,0 m (13'-1")			3,0 m (9'-10")			2,0 m (6'-7")		
A	B												
		Schild Unten	Schild oben	Schild oben	Schild Unten	Schild oben	Schild oben	Schild Unten	Schild oben	Schild oben	Schild Unten	Schild oben	Schild oben
4,0 m (13'-1")		669* (1.475)*	669* (1.475)*	669* (1.475)*	-	-	-	588* (1.297)*	588* (1.297)*	588* (1.297)*	-	-	-
3,0 m (9'-10")		672* (1.482)*	514 (1.134)	556 (1.227)	650* (1.434)*	549 (1.211)	594 (1.310)	721* (1.590)*	721* (1.590)*	721* (1.590)*	-	-	-
2,0 m (6'-7")		697* (1.537)*	433 (955)	469 (1.034)	689* (1.520)*	539 (1.188)	583 (1.286)	726* (1.600)*	726* (1.600)*	726* (1.600)*	-	-	-
1,0 m (3'-3")		730* (1.609)*	404 (891)	438 (967)	798* (1.759)*	516 (1.138)	560 (1.236)	1.020* (2.250)*	786 (1.734)	859 (1.894)	1.797* (3.963)*	1.435 (3.164)	1.607 (3.544)
0,0 m (0'-0")		769* (1.697)*	411 (905)	446 (983)	891* (1.965)*	496 (1.095)	540 (1.191)	1.245* (2.745)*	741 (1.634)	813 (1.792)	2.206* (4.865)*	1.347 (2.971)	1.515 (3.340)
- 1,0 m (-3'-3")		813* (1.792)*	462 (1.020)	503 (1.109)	881* (1.943)*	490 (1.081)	534 (1.177)	1.283* (2.830)*	726 (1.600)	797 (1.757)	2.115* (4.663)*	1.341 (2.958)	1.508 (3.326)
- 2,0 m (-6'-7")		843* (1.859)*	626 (1.381)	683 (1.507)	-	-	-	1.055* (2.326)*	740 (1.631)	811 (1.789)	1.692* (3.731)*	1.371 (3.024)	1.540 (3.396)

Tab.2: Hubkrafttabelle ET35-STD ohne Zusatzgewicht, Gummikette, langer Löffelstiel



**Hubkrafttabellen ET35**

					4,0 m (13'-1")			3,0 m (9'-10")			2,0 m (6'-7")		
A	B												
		Schild Unten	Schild oben	Schild oben	Schild Unten	Schild oben	Schild oben	Schild Unten	Schild oben	Schild oben	Schild Unten	Schild oben	Schild oben
4,0 m (13'-1")		738* (1.627)*	738* (1.627)*	738* (1.627)*	-	-	-	-	-	-	-	-	-
3,0 m (9'-10")		738* (1.626)*	646 (1.424)	697 (1.537)	-	-	-	654* (1.443)*	654* (1.443)*	654* (1.443)*	-	-	-
2,0 m (6'-7")		761* (1.677)*	538 (1.187)	581 (1.280)	758* (1.672)*	607 (1.339)	656 (1.446)	829* (1.828)*	829* (1.828)*	829* (1.828)*	1.065* (2.348)*	1.065* (2.348)*	1.065* (2.348)*
1,0 m (3'-3")		794* (1.752)*	502 (1.107)	542 (1.196)	851* (1.875)*	588 (1.298)	636 (1.403)	1108* (2.443)*	882 (1.946)	962 (2.121)	2.041* (4.500)*	1.582 (3.489)	1.769 (3.901)
0,0 m (0'-0")		835* (1.841)*	514 (1.133)	556 (1.226)	920* (2.028)*	573 (1.263)	620 (1.368)	1.292* (2.848)*	846 (1.865)	924 (2.037)	2.233* (4.923)*	1.534 (3.382)	1.718 (3.788)
- 1,0 m (-3'-3")		877* (1.934)*	589 (1.298)	638 (1.407)	-	-	-	1.276* (2.814)*	837 (1.846)	915 (2.018)	2.042* (4.502)*	1.540 (3.395)	1.724 (3.802)
- 2,0 m (-6'-7")		886* (1.953)*	848 (1.869)	886* (1.953)*	-	-	-	912* (2.011)*	862 (1.900)	912* (2.011)*	1.510* (3.330)*	1.510* (3.330)*	1.510* (3.330)*













Tab.3: Hubkrafttabelle ET35-STD mit Zusatzgewicht, Gummikette, kurzer Löffelstiel

					4,0 m (13'-1")			3,0 m (9'-10")			2,0 m (6'-7")		
A	B												
		Schild Unten	Schild oben	Schild oben	Schild Unten	Schild oben	Schild oben	Schild Unten	Schild oben	Schild oben	Schild Unten	Schild oben	Schild oben
4,0 m (13'-1")		669* (1.475)*	669* (1.475)*	669* (1.475)*	-	-	-	588* (1.297)*	588* (1.297)*	588* (1.297)*	-	-	-
3,0 m (9'-10")		672* (1.482)*	578 (1.273)	623 (1.375)	650* (1.434)*	615 (1.357)	650* (1.434)*	721* (1.590)*	721* (1.590)*	721* (1.590)*	-	-	-
2,0 m (6'-7")		697* (1.537)*	489 (1.079)	529 (1.166)	689* (1.520)*	605 (1.334)	654 (1.441)	726* (1.600)*	726* (1.600)*	726* (1.600)*	-	-	-
1,0 m (3'-3")		730* (1.609)*	459 (1.011)	496 (1.94)	798* (1.759)*	583 (1.284)	631 (1.391)	1.020* (2.250)*	882 (1.944)	961 (2.120)	1.797* (3.963)*	1.606 (3.540)	1.795 (3.958)
0,0 m (0'-0")		769* (1.697)*	467 (1.029)	505 (1.114)	891* (1.965)*	563 (1.241)	610 (1.346)	1.245* (2.745)*	837 (1.845)	915 (2.018)	2.206* (4.865)*	1.518 (3.348)	1.702 (3.754)
- 1,0 m (-3'-3")		813* (1.792)*	525 (1.158)	569 (1.255)	881* (1.943)*	557 (1.227)	604 (1.332)	1.283* (2.830)*	821 (1.811)	899 (1.982)	2.115* (4.663)*	1.512 (3.335)	1.696 (3.740)
- 2,0 m (-6'-7")		843* (1.859)*	707 (1.560)	770 (1.698)	-	-	-	1.055* (2.326)*	835 (1.842)	914 (2.014)	1.692* (3.731)*	1.542 (3.400)	1.692* (3.731)*













Tab.4: Hubkrafttabelle ET35-STD mit Zusatzgewicht, Gummikette, langer Löffelstiel



**Hubkrafttabellen ET35**

					4,0 m (13'-1")			3,0 m (9'-10")			2,0 m (6'-7")		
A	B												
		Schild Unten	Schild oben	Schild oben	Schild Unten	Schild oben	Schild oben	Schild Unten	Schild oben	Schild oben	Schild Unten	Schild oben	Schild oben
4,0 m (13'-1")		738* (1.627)*	738* (1.627)*	738* (1.627)*	-	-	-	-	-	-	-	-	-
3,0 m (9'-10")		738* (1.627)*	598 (1.319)	648 (1.428)	-	-	-	654* (1.443)*	654* (1.443)*	654* (1.443)*	-	-	-
2,0 m (6'-7")		761* (1.677)*	496 (1.094)	538 (1.185)	758* (1.672)*	562 (1.238)	608 (1.341)	829* (1.828)*	829* (1.828)*	829* (1.828)*	1.065* (2.348)*	1.065* (2.348)*	1.065* (2.348)*
1,0 m (3'-3")		794* (1.752)*	462 (1.019)	501 (1.105)	851* (1.875)*	543 (1.196)	589 (1.299)	1.108* (2.443)*	816 (1.800)	893 (1.968)	2.041* (4.500)*	1.464 (3.228)	1.643 (3.622)
0,0 m (0'-0")		835* (1.841)*	472 (1.042)	513 (1.131)	920* (2.028)*	527 (1.162)	573 (1.263)	1.292* (2.848)*	780 (1.719)	855 (1.885)	2.233* (4.923)*	1.415 (3.121)	1.591 (3.509)
-1,0 m (-3'-3")		877* (1.934)*	542 (1.194)	589 (1.299)	-	-	-	1.276* (2.814)*	771 (1.700)	846 (1.866)	2.042* (4.502)*	1.421 (3.134)	1.597 (3.522)
-2,0 m (-6'-7")		886* (1.953)*	783 (1.726)	857 (1.889)	-	-	-	912* (2.011)*	796 (1.755)	872 (1.922)	1.510* (3.330)*	1.458 (3.215)	1.510* (3.330)*

Tab.5: Hubkrafttabelle ET35-STD ohne Zusatzgewicht, Stahlkette, kurzer Löffelstiel

					4,0 m (13'-1")			3,0 m (9'-10")			2,0 m (6'-7")		
A	B												
		Schild Unten	Schild oben	Schild oben	Schild Unten	Schild oben	Schild oben	Schild Unten	Schild oben	Schild oben	Schild Unten	Schild oben	Schild oben
4,0 m (13'-1")		669* (1.475)*	669* (1.475)*	669* (1.475)*	-	-	-	588* (1.297)*	588* (1.297)*	588* (1.297)*	-	-	-
3,0 m (9'-10")		672* (1.482)*	534 (1.177)	578 (1.275)	650* (1.434)*	570 (1.256)	617 (1.360)	721* (1.590)*	721* (1.590)*	721* (1.590)*	-	-	-
2,0 m (6'-7")		697* (1.537)*	450 (993)	488 (1.077)	689* (1.520)*	559 (1.233)	606 (1.337)	726* (1.600)*	726* (1.600)*	726* (1.600)*	-	-	-
1,0 m (3'-3")		730 (1.609)*	421 (928)	457 (1.008)	798 (1.759)*	537 (1.183)	583 (1.286)	1.020 (2.250)*	816 (1.798)	892 (1.968)	1.797 (3.963)*	1.487 (3.279)	1.668 (3.678)
0,0 m (0'-0")		769* (1.697)*	428 (944)	465 (1.026)	891* (1.965)*	517 (1.140)	563 (1.241)	1.245* (2.745)*	771 (1.699)	846 (1.865)	2.206* (4.865)*	1.400 (3.087)	1.576 (3.474)
-1,0 m (-3'-3")		813* (1.792)*	482 (1.062)	525 (1.157)	881* (1.943)*	511 (1.126)	557 (1.228)	1.283* (2.830)*	755 (1.665)	830 (1.830)	2.115* (4.663)*	1.394 (3.074)	1.569 (3.461)
-2,0 m (-6'-7")		843* (1.859)*	651 (1.436)	712 (1.569)	-	-	-	1.055* (2.326)*	769 (1.696)	845 (1.862)	1.692* (3.731)*	1.424 (3.139)	1.601 (3.530)

Tab.6: Hubkrafttabelle ET35-STD ohne Zusatzgewicht, Stahlkette, langer Löffelstiel



**Hubkrafttabellen ET35**

					4,0 m (13'-1")			3,0 m (9'-10")			2,0 m (6'-7")		
A	B												
		Schild Unten	Schild oben	Schild oben	Schild Unten	Schild oben	Schild oben	Schild Unten	Schild oben	Schild oben	Schild Unten	Schild oben	Schild oben
4,0 m (13'-1")		738* (1.627)*	738* (1.627)*	738* (1.627)*	-	-	-	-	-	-	-	-	-
3,0 m (9'-10")		738* (1.627)*	667 (1.471)	721 (1.589)	-	-	-	654* (1.443)*	654* (1.443)*	654* (1.443)*	-	-	-
2,0 m (6'-7")		761* (1.677)*	557 (1.227)	601 (1.326)	758* (1.672)*	628 (1.384)	679 (1.496)	829* (1.828)*	829* (1.828)*	829* (1.828)*	1.065* (2.348)*	1.065* (2.348)*	1.065* (2.348)*
1,0 m (3'-3")		794* (1.752)*	520 (1.147)	562 (1.240)	851* (1.875)*	609 (1.342)	659 (1.454)	1.108* (2.443)*	912 (2.010)	995 (2.194)	2.041* (4.500)*	1.635 (3.605)	1.830 (4.036)
0,0 m (0'-0")		835* (1.841)*	532 (1.174)	576 (1.271)	920* (2.028)*	593 (1.308)	643 (1.418)	1.292* (2.848)*	875 (1.930)	957 (2.111)	2.233* (4.923)*	1.586 (3.498)	1.779 (3.923)
-1,0 m (-3'-3")		877* (1.934)*	610 (1.344)	661 (1.458)	-	-	-	1.276* (2.814)*	867 (1.911)	948 (2.091)	2.042* (4.502)*	1.592 (3.510)	1.785 (3.936)
-2,0 m (-6'-7")		886* (1.953)*	876 (1.933)	886* (1.953)*	-	-	-	912* (2.011)*	891 (1.965)	912* (2.011)*	1.510* (3.330)*	1.510* (3.330)*	1.510* (3.330)*

Tab.7: Hubkrafttabelle ET35-STD mit Zusatzgewicht, Stahlkette, kurzer Löffelstiel

					4,0 m (13'-1")			3,0 m (9'-10")			2,0 m (6'-7")		
A	B												
		Schild Unten	Schild oben	Schild oben	Schild Unten	Schild oben	Schild oben	Schild Unten	Schild oben	Schild oben	Schild Unten	Schild oben	Schild oben
4,0 m (13'-1")		669* (1.475)*	669* (1.475)*	669* (1.475)*	-	-	-	588* (1.297)*	588* (1.297)*	588* (1.297)*	-	-	-
3,0 m (9'-10")		672* (1.482)*	597 (1.316)	645 (1.423)	650* (1.434)*	636 (1.402)	650* (1.434)*	721* (1.590)*	721* (1.590)*	721* (1.590)*	-	-	-
2,0 m (6'-7")		697* (1.537)*	507 (1.117)	548 (1.208)	689* (1.520)*	625 (1.379)	676 (1.492)	726* (1.600)*	726* (1.600)*	726* (1.600)*	-	-	-
1,0 m (3'-3")		730* (1.609)*	475 (1.048)	515 (1.135)	798* (1.759)*	603 (1.329)	654 (1.441)	1.020* (2.250)*	911 (2.009)	995 (2.193)	1.797* (3.963)*	1.658 (3.656)	1.797* (3.963)*
0,0 m (0'-0")		769* (1.697)*	484 (1.067)	525 (1.157)	891* (1.965)*	583 (1.286)	633 (1.396)	1.245* (2.745)*	866 (1.910)	948 (2.091)	2.206* (4.865)*	1.571 (3.463)	1.763 (3.888)
-1,0 m (-3'-3")		813* (1.792)*	544 (1.200)	591 (1.303)	881* (1.943)*	577 (1.272)	627 (1.383)	1.283* (2.830)*	850 (1.875)	932 (2.055)	2.115* (4.663)*	1.565 (3.450)	1.757 (3.875)
-2,0 m (-6'-7")		843* (1.859)*	732 (1.614)	798 (1.760)	-	-	-	1.055* (2.326)*	865 (1.906)	947 (2.088)	1.692* (3.731)*	1.595 (3.516)	1.692* (3.731)*

Tab.8: Hubkrafttabelle ET35-STD mit Zusatzgewicht, Stahlkette, langer Löffelstiel



**WACKER  
NEUSON**

*all it takes!*

**Hubkrafttabellen ET35**

					4,0 m (13'-1")			3,0 m (9'-10")			2,0 m (6'-7")		
A	B												
		Schild Unten	Schild oben		Schild Unten	Schild oben		Schild Unten	Schild oben		Schild Unten	Schild oben	
4,0 m (13'-1")		713* (1.572)*	713* (1.572)*	713* (1.572)*	-	-	-	698* (1.540)*	698* (1.540)*	698* (1.540)*	-	-	-
3,0 m (9'-10")		716* (1.578)*	585 (1.289)	641 (1.414)	-	-	-	640* (1.412)*	640* (1.412)*	640* (1.412)*	-	-	-
2,0 m (6'-7")		739* (1.630)*	491 (1.082)	539 (1.188)	740* (1.632)*	559 (1.233)	614 (1.354)	823* (1.815)*	823* (1.815)*	823* (1.815)*	1.106* (2.439)*	1.106* (2.439)*	1.106* (2.439)*
1,0 m (3'-3")		772* (1.703)*	460 (1.015)	506 (1.117)	831* (1.833)*	540 (1.191)	594 (1.310)	1.093* (2.410)*	811 (1.788)	899 (1.982)	2.022* (4.459)*	1.452 (3.202)	1.651 (3.641)
0,0 m (0'-0")		812* (1.791)*	474 (1.046)	523 (1.152)	892* (1.967)*	525 (1.158)	579 (1.277)	1.151* (2.538)*	776 (1.712)	863 (1.903)	2.156* (4.755)*	1.412 (3.114)	1.609 (3.548)
- 1,0 m (-3'-3")		852* (1.879)*	550 (1.213)	607 (1.339)	-	-	-	1.224* (2.700)*	770 (1.698)	857 (1.889)	1.951* (4.302)*	1.420 (3.132)	1.618 (3.567)
- 2,0 m (-6'-7")		853* (1.880)*	823 (1.816)	853* (1.880)*	-	-	-	-	-	-	1.395* (3.075)*	1.395* (3.075)*	1.395* (3.075)*

Tab.9: Hubkrafttabelle ET35-VDS ohne Zusatzgewicht, Gummikette, kurzer Löffelstiel

					4,0 m (13'-1")			3,0 m (9'-10")			2,0 m (6'-7")		
A	B												
		Schild Unten	Schild oben		Schild Unten	Schild oben		Schild Unten	Schild oben		Schild Unten	Schild oben	
4,0 m (13'-1")		642* (1.415)*	642* (1.415)*	642* (1.415)*	-	-	-	555* (1.224)*	555* (1.224)*	555* (1.224)*	-	-	-
3,0 m (9'-10")		653* (1.439)*	522 (1.152)	573 (1.265)	628* (1.384)	569 (1.254)	624 (1.376)	537* (1.185)*	537* (1.185)*	537* (1.185)*	-	-	-
2,0 m (6'-7")		677* (1.493)*	446 (983)	490 (1.080)	675* (1.488)*	556 (1.227)	611 (1.348)	724* (1.596)*	724* (1.596)*	724* (1.596)*	-	-	-
1,0 m (3'-3")		710* (1.565)*	419 (924)	462 (1.018)	782* (1.723)*	534 (1.177)	588 (1.297)	1.011* (2.229)*	809 (1.785)	898 (1.979)	1.804* (3.977)*	1.472 (3.245)	1.673 (3.689)
0,0 m (0'-0")		748* (1.650)*	429 (947)	474 (1.045)	867* (1.912)*	515 (1.135)	569 (1.254)	1.216* (2.681)*	767 (1.691)	854 (1.882)	2.142* (4.723)*	1.395 (3.076)	1.592 (3.510)
- 1,0 m (-3'-3")		790* (1.742)*	488 (1.076)	539 (1.189)	843* (1.859)*	510 (1.125)	564 (1.244)	1.237* (2.727)*	753 (1.661)	840 (1.852)	2.028* (4.472)*	1.392 (3.070)	1.589 (3.504)
- 2,0 m (-6'-7")		816* (1.800)*	676 (1.491)	750 (1.653)	-	-	-	982* (2.166)*	771 (1.700)	858 (1.891)	1.585* (3.495)*	1.425 (3.143)	1.585* (3.495)*

Tab.10: Hubkrafttabelle ET35-VDS ohne Zusatzgewicht, Gummikette, langer Löffelstiel



**Hubkrafttabellen ET35**

					4,0 m (13'-1")			3,0 m (9'-10")			2,0 m (6'-7")		
A	B												
		Schild Unten	Schild oben	Schild hinten	Schild Unten	Schild oben	Schild hinten	Schild Unten	Schild oben	Schild hinten	Schild Unten	Schild oben	Schild hinten
4,0 m (13'-1")		713* (1.572)*	713* (1.572)*	713* (1.572)*	-	-	-	698* (1.540)*	698* (1.540)*	698* (1.540)*	-	-	-
3,0 m (9'-10")		716* (1.578)*	652 (1.438)	713 (1.572)	-	-	-	640* (1.412)*	640* (1.412)*	640* (1.412)*	-	-	-
2,0 m (6'-7")		739* (1.630)*	551 (1.214)	602 (1.328)	740* (1.632)*	625 (1.379)	684 (1.509)	823* (1.815)*	823* (1.815)*	823* (1.815)*	1.106* (2.439)*	1.106* (2.439)*	1.106* (2.439)*
1,0 m (3'-3")		772* (1.703)*	518 (1.143)	568 (1.252)	831* (1.833)*	606 (1.337)	665 (1.465)	1.093* (2.410)*	906 (1.998)	1.001 (2.207)	2.022* (4.459)*	1.623 (3.578)	1.839 (4.055)
0,0 m (0'-0")		812* (1.791)*	535 (1.179)	587 (1.293)	892* (1.967)*	591 (1.304)	649 (1.432)	1.151* (2.538)*	872 (1.923)	965 (2.129)	2.156* (4.755)*	1.583 (3.490)	1.797 (3.962)
- 1,0 m (-3'-3")		852* (1.879)*	619 (1.366)	681 (1.501)	-	-	-	1.224* (2.700)*	866 (1.909)	959 (2.114)	1.951* (4.302)*	1.591 (3.508)	1.805 (3.981)
- 2,0 m (-6'-7")		853* (1.880)*	853* (1.880)*	853* (1.880)*	-	-	-	-	-	-	1.395* (3.075)*	1.395* (3.075)*	1.395* (3.075)*

Tab.11: Hubkrafttabelle ET35-VDS mit Zusatzgewicht, Gummikette, kurzer Löffelstiel

					4,0 m (13'-1")			3,0 m (9'-10")			2,0 m (6'-7")		
A	B												
		Schild Unten	Schild oben	Schild hinten	Schild Unten	Schild oben	Schild hinten	Schild Unten	Schild oben	Schild hinten	Schild Unten	Schild oben	Schild hinten
4,0 m (13'-1")		642* (1.415)*	642* (1.415)*	642* (1.415)*	-	-	-	555* (1.245)*	555* (1.245)*	555* (1.245)*	-	-	-
3,0 m (9'-10")		653* (1.439)*	585 (1.290)	640 (1.410)	628* (1.384)*	628* (1.384)*	628* (1.384)*	537* (1.185)*	537* (1.185)*	537* (1.185)*	-	-	-
2,0 m (6'-7")		677* (1.493)*	502 (1.106)	549 (1.211)	675* (1.488)*	623 (1.373)*	675* (1.488)*	724* (1.596)*	724* (1.596)*	724* (1.596)*	-	-	-
1,0 m (3'-3")		710* (1.565)*	474 (1.045)	519 (1.145)	782* (1.723)*	600 (1.323)	659 (1.452)	1.011* (2.229)*	905 (1.995)	1.000 (2.205)	1.804* (3.977)*	1.642 (3.621)	1.804* (3.977)*
0,0 m (0'-0")		748* (1.650)*	486 (1.071)	533 (1.176)	867* (1.912)*	581 (1.281)	639 (1.409)	1.216* (2.681)*	862 (1.901)	956 (2.108)	2.142* (4.723)*	1.566 (3.453)	1.780 (3.924)
- 1,0 m (-3'-3")		790* (1.742)*	552 (1.216)	607 (1.338)	843* (1.859)*	576 (1.271)	634 (1.399)	1.237* (2.727)*	849 (1.872)	942 (2.078)	2.028* (4.472)*	1.563 (3.447)	1.777 (3.918)
- 2,0 m (-6'-7")		816* (1.800)*	760 (1.676)	816* (1.800)*	-	-	-	982* (2.166)*	866 (1.910)	960 (2.117)	1.585* (3.495)*	1.585* (3.495)*	1.585* (3.495)*

Tab.12: Hubkrafttabelle ET35-VDS mit Zusatzgewicht, Gummikette, langer Löffelstiel



**Hubkrafttabellen ET35**

					4,0 m (13'-1")			3,0 m (9'-10")			2,0 m (6'-7")		
A	B												
		Schild Unten	Schild oben		Schild Unten	Schild oben		Schild Unten	Schild oben		Schild Unten	Schild oben	
4,0 m (13'-1")		713* (1.572)*	713* (1.572)*	713* (1.572)*	-	-	-	698* (1.540)*	698* (1.540)*	698* (1.540)*	-	-	-
3,0 m (9'-10")		716* (1.578)*	605 (1.335)	665 (1.465)	-	-	-	640* (1.412)*	640* (1.412)*	640* (1.412)*	-	-	-
2,0 m (6'-7")		739* (1.630)*	509 (1.123)	559 (1.234)	740* (1.632)*	580 (1.278)	637 (1.404)	823* (1.815)*	823* (1.815)*	823* (1.815)*	1.106* (2.439)*	1.106* (2.439)*	1.106* (2.439)*
1,0 m (3'-3")		772* (1.703)*	478 (1.055)	526 (1.161)	831* (1.833)*	560 (1.235)	617 (1.361)	1.093* (2.410)*	840 (1.853)	932 (2.055)	2.022* (4.459)*	1.504 (3.317)	1.712 (3.776)
0,0 m (0'-0")		812* (1.791)*	493 (1.087)	543 (1.198)	892* (1.967)*	545 (1.203)	602 (1.327)	1.151* (2.538)*	806 (1.777)	896 (1.977)	2.156* (4.755)*	1.465 (3.230)	1.670 (3.683)
-1,0 m (-3'-3")		852* (1.879)*	572 (1.260)	631 (1.392)	-	-	-	1.224* (2.700)*	799 (1.763)	890 (1.962)	1.951* (4.302)*	1.473 (3.247)	1.679 (3.701)
-2,0 m (-6'-7")		853* (1.880)*	853* (1.880)*	853* (1.880)*	-	-	-	-	-	-	1.395* (3.075)*	1.395* (3.075)*	1.395* (3.075)*

Tab.13: Hubkrafttabelle ET35-VDS ohne Zusatzgewicht, Stahlkette, kurzer Löffelstiel





					4,0 m (13'-1")			3,0 m (9'-10")			2,0 m (6'-7")		
A	B												
		Schild Unten	Schild oben		Schild Unten	Schild oben		Schild Unten	Schild oben		Schild Unten	Schild oben	
4,0 m (13'-1")		642* (1.415)*	642* (1.415)*	642* (1.415)*	-	-	-	555* (1.224)*	555* (1.224)*	555* (1.224)*	-	-	-
3,0 m (9'-10")		653* (1.439)*	542 (1.194)	595 (1.312)	628* (1.384)*	589 (1.299)	628* (1.384)*	537* (1.185)*	537* (1.185)*	537* (1.185)*	-	-	-
2,0 m (6'-7")		677* (1.493)*	463 (1.021)	509 (1.123)	675* (1.488)*	577 (1.272)	634 (1.399)	724* (1.596)*	724* (1.596)*	724* (1.596)*	-	-	-
1,0 m (3'-3")		710* (1.565)*	436 (961)	481 (1.060)	782* (1.723)*	554 (1.222)	611 (1.347)	1.011* (2.229)*	839 (1.850)	931 (2.053)	1.804* (3.977)*	1.524 (3.360)	1.734 (3.823)
0,0 m (0'-0")		748* (1.650)*	447 (985)	493 (1.087)	867* (1.912)*	535 (1.180)	592 (1.304)	1.216* (2.681)*	796 (1.755)	887 (1.956)	2.142* (4.723)*	1.447 (3.192)	1.653 (3.644)
-1,0 m (-3'-3")		790* (1.742)*	508 (1.119)	561 (1.238)	843* (1.859)*	531 (1.170)	587 (1.294)	1.237* (2.727)*	783 (1.726)	873 (1.925)	2.028* (4.472)*	1.445 (3.186)	1.650 (3.638)
-2,0 m (-6'-7")		816* (1.800)*	702 (1.548)	779 (1.717)	-	-	-	982* (2.166)*	800 (1.764)	891 (1.965)	1.585* (3.495)*	1.478 (3.259)	1.585* (3.495)*

Tab.14: Hubkrafttabelle ET35-VDS ohne Zusatzgewicht, Stahlkette, langer Löffelstiel



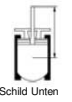

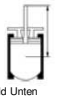
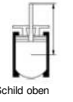
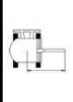

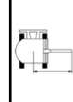
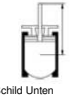
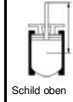
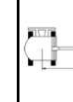

**Hubkrafttabellen ET35**

					4,0 m (13'-1")			3,0 m (9'-10")			2,0 m (6'-7")		
A	B												
		Schild Unten	Schild oben	Schild links	Schild Unten	Schild oben	Schild links	Schild Unten	Schild oben	Schild links	Schild Unten	Schild oben	Schild links
4,0 m (13'-1")		713* (1.572)*	713* (1.572)*	713* (1.572)*	-	-	-	698* (1.540)*	698* (1.540)*	698* (1.540)*	-	-	-
3,0 m (9'-10")		716* (1.578)*	673 (1.484)	716* (1.578)	-	-	-	640* (1.412)*	640* (1.412)*	640* (1.412)*	-	-	-
2,0 m (6'-7")		739* (1.630)*	569 (1.255)	623 (1.373)	740* (1.632)*	646 (1.424)	707 (1.559)*	823* (1.815)*	823* (1.815)*	823* (1.815)*	1.106* (2.439)*	1.106* (2.439)*	1.106* (2.439)*
1,0 m (3'-3")		772* (1.703)*	536 (1.183)	588 (1.296)	831* (1.833)*	627 (1.382)	687 (1.516)	1.093* (2.410)*	936 (2.063)	1.034 (2.280)	2.022* (4.459)*	1.675 (3.694)	1.900 (4.190)
0,0 m (0'-0")		812* (1.791)*	553 (1.220)	607 (1.339)	892* (1.967)*	612 (1.349)	672 (1.482)	1.151* (2.538)*	901 (1.987)	999 (2.202)	2.156* (4.755)*	1.635 (3.606)	1.858 (4.097)
-1,0 m (-3'-3")		852* (1.879)*	641 (1.413)	704 (1.553)	-	-	-	1.224* (2.700)*	895 (1.973)	992 (2.188)	1.951 (4.302)*	1.644 (3.624)	1.866 (4.115)
-2,0 m (-6'-7")		853* (1.880)*	853* (1.880)*	853* (1.880)*	-	-	-	-	-	-	1.395* (3.075)*	1.395* (3.075)*	1.395* (3.075)*

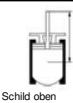
Tab. 15: Hubkrafttabelle ET35-VDS mit Zusatzgewicht, Stahlkette, kurzer Löffelstiel

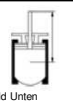
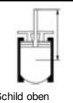
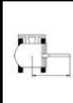
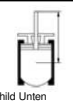
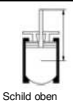
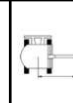
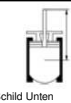
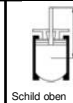
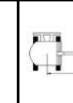
					4,0 m (13'-1")			3,0 m (9'-10")			2,0 m (6'-7")		
A	B												
		Schild Unten	Schild oben	Schild links	Schild Unten	Schild oben	Schild links	Schild Unten	Schild oben	Schild links	Schild Unten	Schild oben	Schild links
4,0 m (13'-1")		642* (1.415)*	642* (1.415)*	642* (1.415)*	-	-	-	555* (1.224)*	555* (1.224)*	555* (1.224)*	-	-	-
3,0 m (9'-10")		653* (1.439)*	604 (1.332)	653* (1.439)*	628* (1.384)*	628* (1.384)*	628* (1.384)*	537* (1.185)*	537* (1.185)*	537* (1.185)*	-	-	-
2,0 m (6'-7")		677* (1.493)*	519 (1.144)	569 (1.254)	675* (1.488)*	643 (1.418)	675* (1.488)*	724* (1.596)*	724* (1.596)*	724* (1.596)*	-	-	-
1,0 m (3'-3")		710* (1.565)*	490 (1.081)	538 (1.187)	782* (1.723)*	620 (1.368)	681 (1.502)	1.011* (2.229)*	934 (2.060)	1.011* (2.229)*	1.804* (3.977)*	1.695 (3.737)	1.804* (3.977)*
0,0 m (0'-0")		748* (1.650)*	503 (1.110)	553 (1.219)	867* (1.912)*	601 (1.326)	662 (1.459)	1.216* (2.681)*	892 (1.966)	989 (2.181)	2.142* (4.723)*	1.618 (3.568)	1.841 (4.058)
-1,0 m (-3'-3")		790* (1.742)*	571 (1.259)	628 (1.386)	843* (1.859)*	597 (1.316)	657 (1.449)	1.237* (2.727)*	878 (1.937)	975 (2.151)	2.028* (4.472)*	1.616 (3.563)	1.838 (4.052)
-2,0 m (-6'-7")		816* (1.800)*	786 (1.733)	816* (1.800)*	-	-	-	982* (2.166)*	896 (1.975)	982* (2.166)*	1.585* (3.495)*	1.585* (3.495)*	1.585* (3.495)*

Tab. 16: Hubkrafttabelle ET35-VDS mit Zusatzgewicht, Stahlkette, langer Löffelstiel