



Hubkrafttabellen EZ17



Abb. 1: Hubkrafttabelle EZ17

Bezeichnung	Erklärung
A	Ausladung von Drehkranzmitte
B	Lasthakenhöhe
max	Zulässige Gewichts- oder Massewert bei gestrecktem Armsystem
	Mit oder ohne Planierschildabstützung in Fahrtrichtung
	Mit oder ohne Planierschildabstützung 90° zur Fahrtrichtung
	Planierschild unten
	Planierschild oben
	Telefahrwerk ausgefahren

Alle Tabellenwerte sind in kg (lbs) angegeben, bei waagrechter Stellung auf tragfestem und ebenem Untergrund ohne Löffel oder einem Anbauwerkzeug.

Die zulässigen Gewichts- oder Massewerte die gehoben werden können, sind durch die folgenden Grenzwerte definiert:

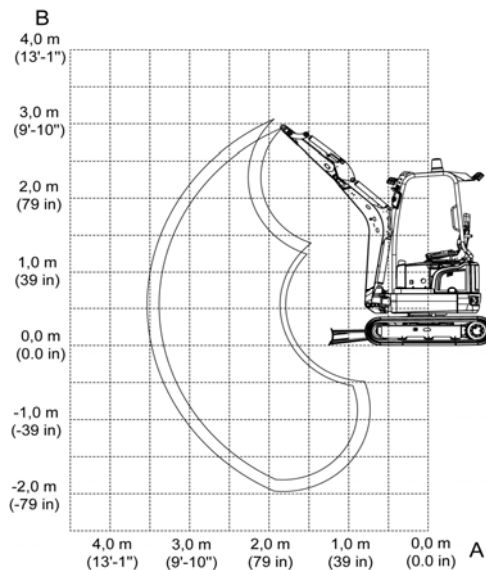
- 75% der statischen Kipplast und
- 87% der hydraulischen Hubkraft Berechnungsgrundlage: gemäß ISO 10567.

Einstelldruck am Hubarmzylinder: 22500 kPa (3,263 psi)

















Die Gewichts- oder Massewerte gelten für Fahrzeuge unter folgenden Bedingungen:

- Schmier- und Betriebsmittel auf den vorgeschriebenen Ständen
- Voller Kraftstofftank
- Canopy
- Fahrzeug auf Betriebstemperatur
- Gewicht des Fahrers 75 kg (165 lbs)



















**WACKER
NEUSON**
all it takes!

Hubkrafttabellen EZ17

A B				3,0 m (9'-10")			2,5 m (98 in)			2,0 m (79 in)			1,5 m (59m)		
															
2,5 m (98 in)	474 (1,045)	302 (666)	274 (603)	-	-	-	469 (1,034)	306 (674)	277 (611)	-	-	-	-	-	-
2,0 m (79 in)	468 (1,032)	231 (510)	207 (456)	-	-	-	431 (950)	308 (678)	279 (615)	-	-	-	-	-	-
1,0 m (39 in)	435 (959)	182 (402)	161 (355)	491 (1,083)	218 (481)	194 (428)	591 (1,303)	291 (641)	262 (577)	781 (1,722)	410 (903)	374 (824)	-	-	-
0,0 m (0.0 in)	404 (891)	179 (394)	157 (346)	493 (1,087)	208 (459)	184 (405)	653 (1,440)	271 (598)	242 (534)	916 (2,020)	376 (828)	339 (747)	-	-	-
-1,0 m (-39 in)	384 (847)	221 (487)	195 (431)	-	-	-	511 (1,127)	269 (593)	239 (528)	705 (1,555)	375 (827)	338 (746)	1034 (2,280)	602 (1,328)	555 (1,224)
-1,5 m (-59 in)	386 (851)	293 (646)	262 (579)	-	-	-	-	-	-	540 (1,191)	383 (845)	346 (764)	811 (1,788)	614 (1,353)	567 (1,250)

















Tab.1: Hubkrafttabellen EZ17– kurzer Löffelstiel

A B				3,0 m (9'-10")			2,5 m (98 in)			2,0 m (79 in)			1,5 m (59m)		
															
2,5 m (98 in)	434 (957)	264 (582)	238 (524)	-	-	-	375 (827)	310 (684)	282 (621)	-	-	-	-	-	-
2,0 m (79 in)	431 (950)	209 (462)	186 (411)	423 (933)	226 (498)	202 (446)	362 (798)	310 (683)	281 (620)	-	-	-	-	-	-
1,0 m (39 in)	405 (893)	168 (371)	148 (326)	471 (1,039)	218 (481)	194 (428)	549 (1,211)	291 (643)	263 (579)	686 (1,513)	414 (913)	378 (834)	-	-	-
0,0 m (0.0 in)	380 (838)	165 (363)	144 (317)	497 (1,096)	206 (454)	182 (400)	655 (1,444)	269 (594)	240 (529)	929 (2,048)	373 (823)	336 (742)	-	-	-
-1,0 m (-39 in)	364 (803)	198 (437)	174 (384)	385 (849)	204 (449)	179 (395)	540 (1,191)	264 (581)	234 (517)	745 (1,643)	368 (812)	331 (731)	1119 (2,467)	591 (1,304)	543 (1,198)
-1,5 m (-59 in)	365 (805)	251 (553)	223 (491)	-	-	-	413 (911)	269 (593)	240 (529)	596 (1,314)	375 (826)	338 (745)	903 (1,991)	602 (1,327)	554 (1,222)

















Tab.2: Hubkrafttabellen EZ17– langer Löffelstiel



Hubkrafttabellen EZ17

A B				3,0 m (9'-10")			2,5 m (98 in)			2,0 m (79 in)			1,5 m (59m)		
															
2,5 m (98 in)	474 (1,045)	326 (719)	299 (659)	-	-	-	469 (1,034)	330 (728)	303 (668)	-	-	-	-	-	-
2,0 m (79 in)	468 (1,032)	251 (553)	228 (502)	-	-	-	431 (950)	332 (732)	305 (672)	-	-	-	-	-	-
1,0 m (39 in)	435 (959)	199 (440)	179 (394)	491 (1,083)	238 (524)	215 (473)	591 (1,303)	315 (694)	287 (633)	781 (1,722)	442 (975)	408 (901)	-	-	-
0,0 m (0.0 in)	404 (891)	196 (432)	175 (386)	493 (1,087)	227 (501)	204 (450)	653 (1,440)	296 (652)	268 (590)	916 (2,020)	408 (901)	374 (824)	-	-	-
-1,0 m (-39 in)	384 (847)	241 (532)	217 (478)	-	-	-	511 (1,127)	293 (646)	265 (584)	705 (1,555)	408 (899)	373 (822)	1034 (2,280)	653 (1,439)	609 (1,343)
-1,5 m (-59 in)	386 (851)	318 (702)	289 (638)	-	-	-	-	-	-	540 (1,191)	416 (917)	381 (841)	811 (1,788)	664 (1,465)	621 (1,370)

Tab.3: Hubkrafttabellen EZ17– kurzer Löffelstiel und Zusatzgewicht

A B				3,0 m (9'-10")			2,5 m (98 in)			2,0 m (79 in)			1,5 m (59m)		
															
2,5 m (98 in)	434 (957)	285 (629)	260 (574)	-	-	-	375 (827)	334 (737)	307 (677)	-	-	-	-	-	-
2,0 m (79 in)	431 (950)	228 (502)	206 (453)	423 (933)	245 (541)	222 (490)	362 (798)	334 (737)	307 (677)	-	-	-	-	-	-
1,0 m (39 in)	405 (893)	184 (406)	165 (363)	471 (1,039)	237 (523)	214 (472)	549 (1,211)	316 (696)	288 (636)	686 (1,513)	447 (985)	413 (911)	-	-	-
0,0 m (0.0 in)	380 (838)	181 (398)	161 (354)	497 (1,096)	225 (496)	202 (445)	655 (1,444)	293 (647)	265 (585)	929 (2,048)	406 (895)	371 (818)	-	-	-
-1,0 m (-39 in)	364 (803)	217 (478)	194 (428)	385 (849)	223 (491)	200 (440)	540 (1,191)	288 (635)	260 (573)	745 (1,643)	401 (885)	366 (808)	1119 (2,467)	642 (1,415)	598 (1,318)
-1,5 m (-59 in)	365 (805)	273 (603)	247 (544)	-	-	-	413 (911)	293 (647)	265 (585)	596 (1,314)	408 (899)	373 (822)	903 (1,991)	652 (1,438)	609 (1,342)

Tab.4: Hubkrafttabellen EZ17– langer Löffelstiel und Zusatzgewicht